



Mallard Pass

Solar Farm

Mallard Pass Solar Farm

outline Construction Traffic Management Plan (oCTMP) [Clean]

Deadline 4 - July 2023

PINS Ref: EN010127

Document Ref: EN010127/APP/7.11.3

Revision P3

Infrastructure Planning (Applications: Prescribed Forms and Procedure) Regulations 2009

Reg 5 (2) (j)

TABLE OF CONTENTS

| | | |
|---|---|----|
| 1 | INTRODUCTION | 1 |
| 2 | CONSTRUCTION ACTIVITIES | 3 |
| 3 | VEHICLE ROUTING AND SITE ACCESS..... | 8 |
| 4 | MITIGATION MEASURES | 15 |
| 5 | IMPLEMENTING, MONITORING AND REVIEW | 19 |

FIGURES

| | |
|---|----|
| FIGURE 2-1: CONSTRUCTION COMPOUND OVERVIEW | 5 |
| FIGURE 3-1: CONSTRUCTION ROUTES OVERVIEW..... | 9 |
| FIGURE 3-2: CONSTRUCTION ROUTES FROM PRIMARY COMPOUND TO SECONDARY COMPOUNDS | 12 |

TABLES

| | |
|--|---|
| TABLE 2-1: ESTIMATED CONSTRUCTION VEHICLE SUMMARY..... | 6 |
|--|---|

APPENDICES

| |
|--|
| APPENDIX A ORDER LIMITS |
| APPENDIX B CONSTRUCTION COMPOUND OVERVIEW |
| APPENDIX C A1621 ESSENDINE ROAD / UFFINGTON LANE WORKS |
| APPENDIX D PROPOSED PRIMARY COMPOUND ACCESS |
| APPENDIX E ACCESS FROM PRIMARY TO SECONDARY COMPOUND |
| APPENDIX F SWEEP PATH ANALYSIS |
| APPENDIX G OUTLINE TRAVEL PLAN |



1 INTRODUCTION

1.1 PURPOSE OF DOCUMENT

- 1.1.1 This document provides an outline Construction Traffic Management Plan (oCTMP) for the Mallard Pass Solar Farm Development Consent Order (DCO) application (hereafter referred to as ‘the Proposed Development’). A final CTMP will be produced for each phase (or more than one phase) of the Proposed Development as secured by the DCO prior to commencing construction, which will be required to be in accordance with this oCTMP submitted as part of the DCO Application.
- 1.1.2 The oCTMP will provide mitigation for the traffic generated during the construction phase of the Proposed Development. This will ensure that the potential impact on existing users of the public highway network, or those located close to it, is limited by as much as is practicably possible.
- 1.1.3 The measures proposed within the oCTMP will be agreed prior to commencement of construction works with the relevant planning authorities, and in consultation with the relevant highway authorities. The final CTMP will be prepared following the appointment of a principal construction contractor, prior to the start of works and in accordance with this oCTMP.
- 1.1.4 This oCTMP covers the principal construction activities envisaged at the time of preparing the Environmental Statement (ES) [EN010127/APP/7.11]. This oCTMP is intended to be a live document, such that modifications and necessary interventions can be made following further information and advice from consultees.
- 1.1.5 The appointed principal construction contractor will be responsible for working in accordance with the controls documented in this oCTMP, pursuant to the DCO. The overall responsibility for implementation of the final CTMP will lie with the appointed contractor as a contractual responsibility to the Applicant, as the Applicant is ultimately responsible for compliance with the DCO.
- 1.1.6 This document does not address measures for the operational phase. A Decommissioning Traffic Management Plan (DTMP) will be produced as a subsidiary document to the Decommissioning Environmental Management Plan (DEMP), and agreed with the planning authorities, and in consultation with the relevant highway authorities, prior to the commencement of the works to this phase, as secured by the DCO.
- 1.1.7 The Order Limits are shown at **APPENDIX A** and described in Chapter 3: Description of Order Limits of the ES [EN010127/APP/6.1]
- 1.1.8 They comprise the Solar PV Site, Mitigation and Enhancement Areas, Potential Highway Works Site and the Grid Connection Corridor.
- 1.1.9 The Proposed Development is described in Chapter 5: Project Description of the ES [EN010127/APP/6.1].
- 1.1.10 The Order Limits fall within the administrative boundaries of South Kesteven District Council (SKDC), with Lincolnshire County Council (LCC) as highway authority for the western extent of the Order Limits, and Rutland County Council (RCC), who form the highway authority for the eastern extent of the Order Limits. National Highways form the highway authority for the Strategic Road Network (SRN) in close proximity to the Order Limits.



1.1.11 The administrative boundaries are presented within the Proposed Development layout contained at **APPENDIX A**.

1.2 OBJECTIVES

1.2.1 The objectives of the oCTMP are as follows:

- Keep freight and construction traffic to a minimum, particularly during local network peaks to reduce the impact on the highway network;
- Ensure that the movements of people and materials are achieved in a safe, efficient, timely and sustainable manner; and
- Ensure the continued monitoring, review and subsequent improvement of the final CTMP and mitigation measures proposed.

1.3 POLICY CONTEXT

1.3.1 This oCTMP has been prepared with reference to the following policy and guidance material:

- a. Traffic Management Act (2004);
- b. National Policy Statement for Renewable Energy Infrastructure ('NPS EN-3', 2011), as well as the emerging draft NPS EN-3 (2022);
- c. National Planning Policy Framework ('NPPF', 2021);
- d. RCC Core Development Plan (2011);
- e. LCC Local Transport Plan (2013); and
- f. SKDC Local Plan (2020).

1.4 DOCUMENT STRUCTURE

1.4.1 Following this introduction, this oCTMP is structured as follows:

- **Section 2: Proposed Development** - summarises the proposals and construction methodology;
- **Section 3: Vehicle Routing and Site Access** - details the construction routing and access strategy from both the strategic and local road network;
- **Section 4: Mitigation Measures** - summarises the mitigation strategy and supporting measures that will be implemented; and
- **Section 5: Implementing, Monitoring and Review** - sets out how the oCTMP will be delivered, monitored and reviewed.



2 CONSTRUCTION ACTIVITIES

2.1 CONSTRUCTION DETAILS

2.1.1 Construction activities are provided in detail in Chapter 5: Project Description of the ES. The construction activities undertaken at the construction phase of the Proposed Development will involve:

- Order Limits preparation:
 - Delivery of construction materials, plant and equipment
 - The establishment of Order Limits fencing
 - The establishment of the primary and secondary temporary construction compound(s)
 - The upgrade of existing tracks and construction of new tracks (both temporary and permanent) required
 - The upgrade or construction of crossing points (bridges/culverts) over drainage ditches and below ground utility infrastructure
 - Marking out location of the infrastructure
- Solar Farm construction:
 - Delivery of Proposed Development components
 - Erection of Mounting Structures
 - Mounting of PV Modules
 - Installation of Distribution Cables
 - Installation of String Transformer and / or Central Container Inverters
 - Construction of onsite substation compound
 - Construction of onsite electrical infrastructure to facilitate the export of generated electricity.
 - Testing and commissioning
 - Reinstatement and habitat creation

2.1.2 Temporary construction compounds will be established for the construction phase. A primary construction compound is expected to be located onsite with seven temporary secondary construction compound(s) provided at different locations throughout the Order Limits, as well as temporary roadways, to facilitate access to all parts of the Order Limits.

2.1.3 Details on the transfer of materials from the primary compound to the secondary compounds is discussed within Section 3. The construction compounds will be accessed via the existing points from the local highway network, which will be upgraded.

2.1.4 A plan showing the indicative arrangement and placement of the construction compounds is included at **Figure 2-1** and at **APPENDIX B**.



- 2.1.5 A programme of construction reinstatement and habitat creation will commence during the construction phase. It is anticipated that areas under the PV Arrays and areas within the landscape buffers will be planted with a combination of native grassland mix, wildflower mixes, hedgerows and woodland planted in strategic locations to provide visual screening, ecological habitats and to achieve a minimum 10% biodiversity net gain.

2.2 CONSTRUCTION PROGRAMME

- 2.2.1 The construction phase is anticipated to take 24 months and, subject to being granted consent, the earliest construction is anticipated to start in summer 2026. The final construction programme will be dependent on the final layout design and potential environmental constraints on the timing of construction activities. The ES provides further details of the construction activities, their anticipated duration and indicative programme of each phase of construction works.

2.3 WORKING HOURS

- 2.3.1 Core construction hours will run from 07:00 to 19:00 Monday to Saturday, and no working on Sundays or Bank Holidays. Heavy Goods Vehicle (HGV) deliveries to the Order Limits and works likely to generate substantial levels of noise, aside from Horizontal Directional Drilling (HDD), would be limited to daytime hours of 07:00 to 19:00 during weekdays or Saturday mornings (until 13:00 hours), unless otherwise agreed with the relevant local authority.
- 2.3.2 HDD drilling could be required outside of the assumed day-time construction hours (i.e. evening, Sundays, Bank Holidays or at night).
- 2.3.3 Working days will be one 12-hour shift, with employees travelling to and from the Order Limits an hour either side of the 12-hour shift (i.e. between 06:00 and 07:00, and 19:00 and 20:00). Where onsite works are to be conducted outside the core working hours, this will be agreed with the relevant local authority.



Figure 2-1: Construction Compound Overview

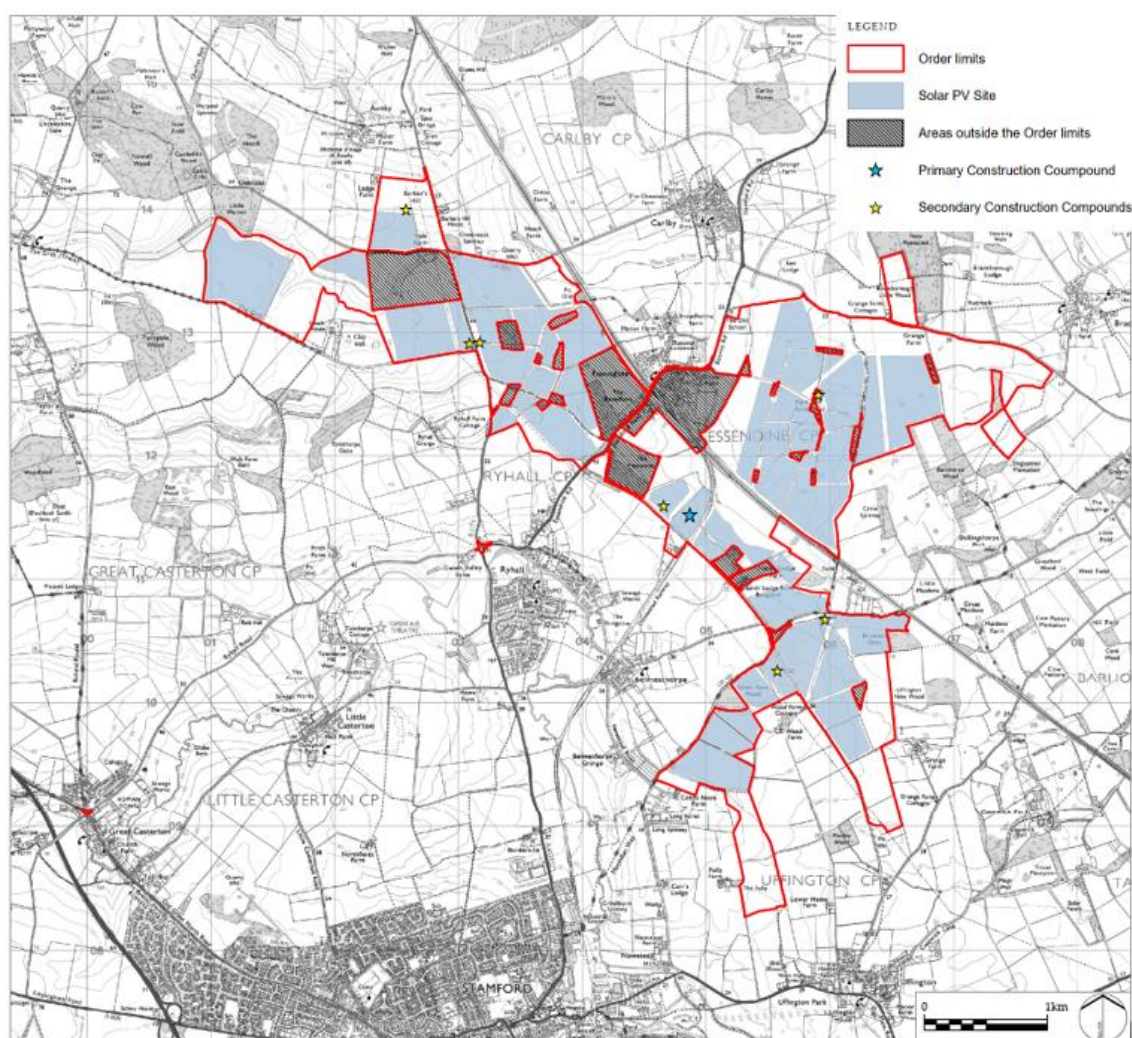

2.4 STAFF AND PARKING

- 2.4.1 At present, it is assumed that the construction of the Proposed Development will require an average of 100 to 150 staff to be across the Order Limits at one time, with potential for up to a maximum of 400 staff.
- 2.4.2 A dedicated temporary car park will be provided for staff, who will then be transported from the temporary car park to the respective construction areas via a shuttle bus. Car parking provision for up to 150 cars will be allowed for within the temporary car parking area.
- 2.4.3 Car parking will not be permitted outside of the primary compound on verges adjacent to the local highway network. All vehicles will be required to park within the extent of the Order Limits.
- 2.4.4 Parking for HGVs will be provided for internally within the extent of the Order Limits.
- 2.4.5 Initially, the temporary car park will be located within the primary compound; however, this may be relocated to other parts of the Order Limits, subject to the construction methodology. Further information on the temporary car park arrangements will be confirmed within later iterations of the CTMP once the principal contractor is appointed and full details are available on staffing numbers.



2.5 CONSTRUCTION EQUIPMENT

2.5.1 It is considered that, as a non-exhaustive list, the following vehicles are likely to be required to facilitate construction of the Proposed Development:

- Excavators
- Cranes
- Ramming machines
- Telehandlers
- Cable layers
- Forklifts
- Waste vehicles
- Cable pullers
- Trenching machines
- Loaders
- Graders
- Compactors
- Tractor with trailer

2.5.2 In addition to the vehicles noted above, the Proposed Development will require the movement of Abnormal Indivisible Loads (AIL) to transport plant to the Order Limits.

2.5.3 The Road Vehicles (Authorisation of Special Types) General Order 2003 sets out the categories of AILs with regard to weight, width and length. Depending on the size of the plant to be transported different arrangements may be required in terms of temporary traffic management and the management and timing of these movements. These movements will be required to meet the standards and guidelines as set out in the Road Vehicles (Authorisation of Special Types) General Order 2003.

2.5.4 For information, the Special Types General Order (STGO) categories are as follows:

- STGO Category 1 – maximum gross vehicle weight 46,000kg (5 axles) or 50,000kg (6 axles)
- STGO Category 2 – maximum gross vehicle weight 80,000kg
- STGO Category 3 – maximum gross vehicle weight 150,000kg

2.6 ESTIMATED VEHICLE NUMBERS

2.6.1 Based on the methodology agreed with LCC and RCC, indicative estimates for the number of construction vehicles are provided in **Table 2-1**.

Table 2-1: Estimated Construction Vehicle Summary

| DAILY TWO-WAY TOTAL VEHICLE PEAK | | DAILY TWO-WAY HGVS PEAK | AVERAGE DAILY TWO-WAY VEHICLES | |
|----------------------------------|-----|-------------------------|--------------------------------|-----|
| LGV | HGV | HGV | LGV | HGV |
| 105 | 41 | 54 | 58 | 42 |

2.6.2 For the purposes of the ES, it is proposed to assume that the peak in LGV trips and HGV trips overlap. The trip generation also includes two additional HGV trips to account for a shuttle bus that is proposed to transport staff from the primary compound to the respective secondary compound, which would be subject to phasing and detailed as part of the future iterations of the final CTMP once the principal contractor is appointed.



- 2.6.3 Whilst in reality there will be phasing and it is unlikely this number of vehicles will consistently be associated with the construction activity on a daily basis, for the purposes of the ES it will be assumed there will be no phasing and the number of vehicles generated will be consistent across the construction programme.
- 2.6.4 This quantum of construction vehicles is assumed as being required across the Order Limits and allows for distribution from the primary compound to the secondary compounds. However, for robustness a sensitivity test is presented within ES Chapter 9 Highways and Access which assesses an uplift in HGV trips to account for HGV trips associated with distribution from the primary compound, that could be associated with a tractor and trailer or equivalent vehicle.
- 2.6.5 On that basis, the proposed development would generate a worst-case of 54 two-way HGVs and 105 two-way LGVs (total of 159 two-way vehicle trips) on a daily basis across the 24-month construction programme.



3 VEHICLE ROUTING AND SITE ACCESS

3.1 ROAD NETWORK

3.1.1 At this stage, it is not possible to determine (or fix) the point of arrival within the United Kingdom for the solar arrays and other components associated with the Proposed Development. On that basis, an initial feasibility exercise has been undertaken to determine potential access routes along the Local Road Network (LRN) to the Order Limits, from the Strategic Road Network (SRN).

STRATEGIC ROAD NETWORK

3.1.2 In terms of the SRN, the A1, which connects Grantham and Stamford, is located approximately 6km west of the centre of the Order Limits. The A47 is located to the south of the Order Limits and passes through Peterborough. The A47 is accessed via the A15, which connects Bourne and Peterborough, which is located approximately 6.5km east of the centre of the Order Limits.

LOCAL ROAD NETWORK

3.1.3 With respect to the LRN, the A47 can also be accessed via the A1175, which is located approximately 4.5km south of the centre of the Order Limits, which provides a vehicular link between Stamford and Market Deeping and a link between Stamford and Oakham along the A606. The A6121, which connects Ryhall, Essendine and Carlby, separates the north-western extent of the Order Limits from the remainder, routing on a general north-east to south-west alignment. The B1176 segments the north-westernmost extent of the Order Limits and is routed on a general north-south direction.

3.2 ACCESS ROUTES

3.2.1 For access from the SRN to the Order Limits via the LRN, the following potential key routes were identified:

- **Route 1** proposes to access the Order Limits from the A1 in the west, which forms part of the SRN, via the B1081 Old Great North Road, Ryhall Road and the A6121 Essendine Road.
- **Route 2** proposes to access the Order Limits from the east and the junction of the A47 with the A15 at Peterborough which forms part of the SRN. Vehicles will travel via the A15, the A1175 Main Road, Uffington Road via Stamford, before joining onto the A6121 Ryhall Road and the A6121 Essendine Road.
- **Route 3** proposes to access the Order Limits via the junction of the A47 with the A15 from the east, before travelling via Bourne (A15) and Raymond Mays Way (south of Bourne), before finally joining onto the A6121 Stamford Road.

3.2.2 An overview of the potential construction routes is provided in **Figure 3-1**.



Figure 3-1: Construction Routes Overview

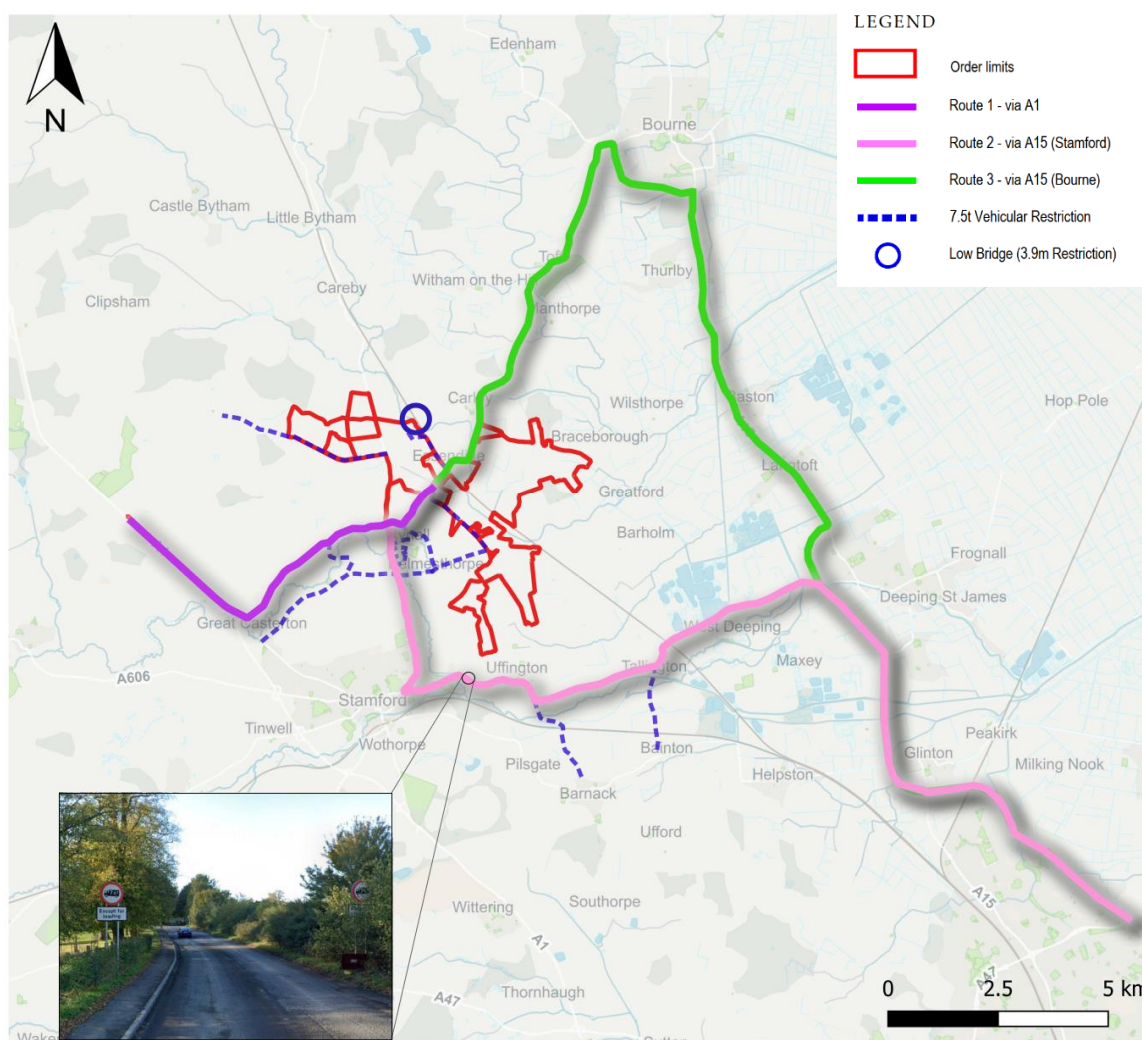

- 3.2.3 As discussed, and agreed with key stakeholders, and to reduce the impact of two-way HGVs on Ryhall Road, it is proposed for HGVs to be required (unless it is not possible) to access the Order Limits via Route 1, enter the primary compound, before departing via Route 3.
- 3.2.4 HGVs will only be allowed to utilise this arrangement and will not utilise Route 2. In the rare instance that Route 1 is not available to be used, HGVs would instead use Route 3; however, appropriate interim traffic management measures will be implemented in those instances to mitigate this scenario until Route 1 reopens. Such interim traffic management measures could involve the use of tidal deliveries and sending all HGVs in platoons, so there is less likelihood of two-way conflicts among construction traffic.
- 3.2.5 This approach has been chosen as Route 1 provides the shortest, most direct route from the SRN, to minimise the distances that any HGVs need to travel. In addition, the A6121 is a road that already accommodates a level of HGV activity, meaning there is a precedent already in place for its use by HGVs.
- 3.2.6 With respect to the use of Route 3 for vehicles exiting the Order Limits, this approach was chosen to minimise the opportunities for any conflicting HGV movements along Route 1.



- 3.2.7 It is noted that there is limited scope for any widening or temporary works along the A6121 to help facilitate two-way HGV flows, so the use of Route 3 reduces the chances for any conflict between HGVs to occur.
- 3.2.8 In order to facilitate this arrangement for construction vehicles, minor works will be required to the junction of the A6121 Essendine Road and Uffington Lane priority junction, including widening, the removal and reinstallation of street furniture, and the implementation of a give-way arrangement to ensure that HGVs can pass simultaneously. A plan showing the extent of the works is included at **APPENDIX C**.
- 3.2.9 The carriageway located at the bend in the road between the north to south and east to west arms of Uffington Lane will be widened to assist in accommodating HGV traffic.
- 3.2.10 Temporary passing places will also be introduced on Uffington Lane to allow for the safe passing of vehicles on that road.
- 3.2.11 The final CTMP will explain when these works will take place, which must be prior to the commencement (as defined in the DCO) of construction of the Scheme. The final CTMP(s) will also be required to confirm that the proposed passing places must be removed upon the completion of construction, in light of the ecological sensitivity of the location of these works.
- 3.2.12 Route 2 was not considered as suitable for HGVs due to the 7.5t weight limit restrictions through Stamford, constrained geometry through key junctions within the Town Centre, as well as known capacity issues throughout the day.
- 3.2.13 It is assumed that all staff and LGV trips will utilise all three routes evenly as the most logical/reasonable route to take. This assumption will be reviewed within the final CTMP once the origin(s) of the construction staff has been confirmed.

3.3 COMPOUND ACCESS

- 3.3.1 The majority of materials would be delivered directly to the primary compound from the LRN network before being unloaded, stored and transported to the secondary compounds by a tractor with a trailer, unless it would not be practicable to do so.
- 3.3.2 The locations identified for the secondary compounds has been based on the proximity to suitable existing access points to the LRN. Where possible, the existing access points to the LRN have been retained; however, minor modifications are required to some of the access points and in a few instances new access points are required.
- 3.3.3 The access points are summarised as follows:
- **Access A:** Provides access to the primary compound from Uffington Lane, using the existing field access with minor works proposed, including new kerbs, carriageway surfacing and the provision of a gate. The road width for this access point has been based on swept path analysis (discussed later in this section) to accommodate two-way HGV flows.
 - **Access B:** Provides access to Field 25 (see Figure 3.2 in the ES which shows field numbers) from Uffington Lane, using the existing field access with minor works proposed, including new kerbs, carriageway surfacing and the provision of a gate.
 - **Access C:** Provides access to Field 49 from Uffington Lane, using the existing field access with minor works proposed, including new kerbs, carriageway surfacing and the provision of a gate.



- **Access D:** Provides access to Field 48 from Uffington Lane, using the existing field access with minor works proposed, including new kerbs, carriageway surfacing and the provision of a gate.
- **Access E:** Provides access to Field 33, relocating the existing point of vehicular field access from Carlby Road further to the east to ensure the access benefits from suitable visibility. The existing point of access to the field to the west will be closed.
- **Access F:** Provides access to Field 6 from the B1176, using the existing field access with minor works proposed, including new kerbs, carriageway surfacing and the provision of a gate.
- **Access G:** Provides access to Field 2 from the B1176, using the existing field access and amending the priority of the existing junction with 'The Drift' with minor works proposed, including new kerbs, carriageway surfacing and the provision of a gate.
- **Access H:** Provides access to Field 4 from the B1176, with a new access created in order to allow for sufficient visibility splays to be provided, with minor works proposed, including new kerbs, carriageway surfacing and the provision of a gate.
- **Access I:** Provides a new internal access between Field 24 and 49 that goes north to south across Main Street, with works including carriageway surfacing, provision of visibility splays and gate.

- 3.3.4 A plan showing the primary construction compound access is provided at **APPENDIX D**. The primary compound will benefit from a 10.2m carriageway width in order to enable two-way access for construction vehicles at the access, as well as ensuring the kerb radii are suitable to allow for construction vehicles to travel in either direction from the primary compound to the secondary compounds.
- 3.3.5 **Figure 3-2** (overleaf) presents the routes for construction vehicles from the primary compound to the secondary compounds, as well as the identified access points. A copy of this plan is also included at **APPENDIX E**.
- 3.3.6 Each access track leading to a secondary compound will have a 6.5m wide carriageway, with a gate located 20m from the edge of the public highway, to enable vehicles to pull off the public highway and wait before entering the Order Limits. Visibility from each access point will be provided in accordance with the industry standard design guidance from the Design Manual for Roads and Bridges (DMRB), taking into consideration the relevant road speed.
- 3.3.7 Swept path analysis showing access to the remainder of the parcels from the LRN is provided at **APPENDIX F**. The swept path analysis shows access for a 16.5m articulated HGV, a tractor and trailer, and an 80t crane.
- 3.3.8 **APPENDIX F** also includes swept path analysis of a 16.5m articulated HGV travelling eastbound along Route 1 and passing a large car on the way to the primary construction compound, as well as a tractor and trailer passing a car to/from the primary construction compound to the secondary compounds.



Figure 3-2: Construction Routes from Primary Compound to Secondary Compounds

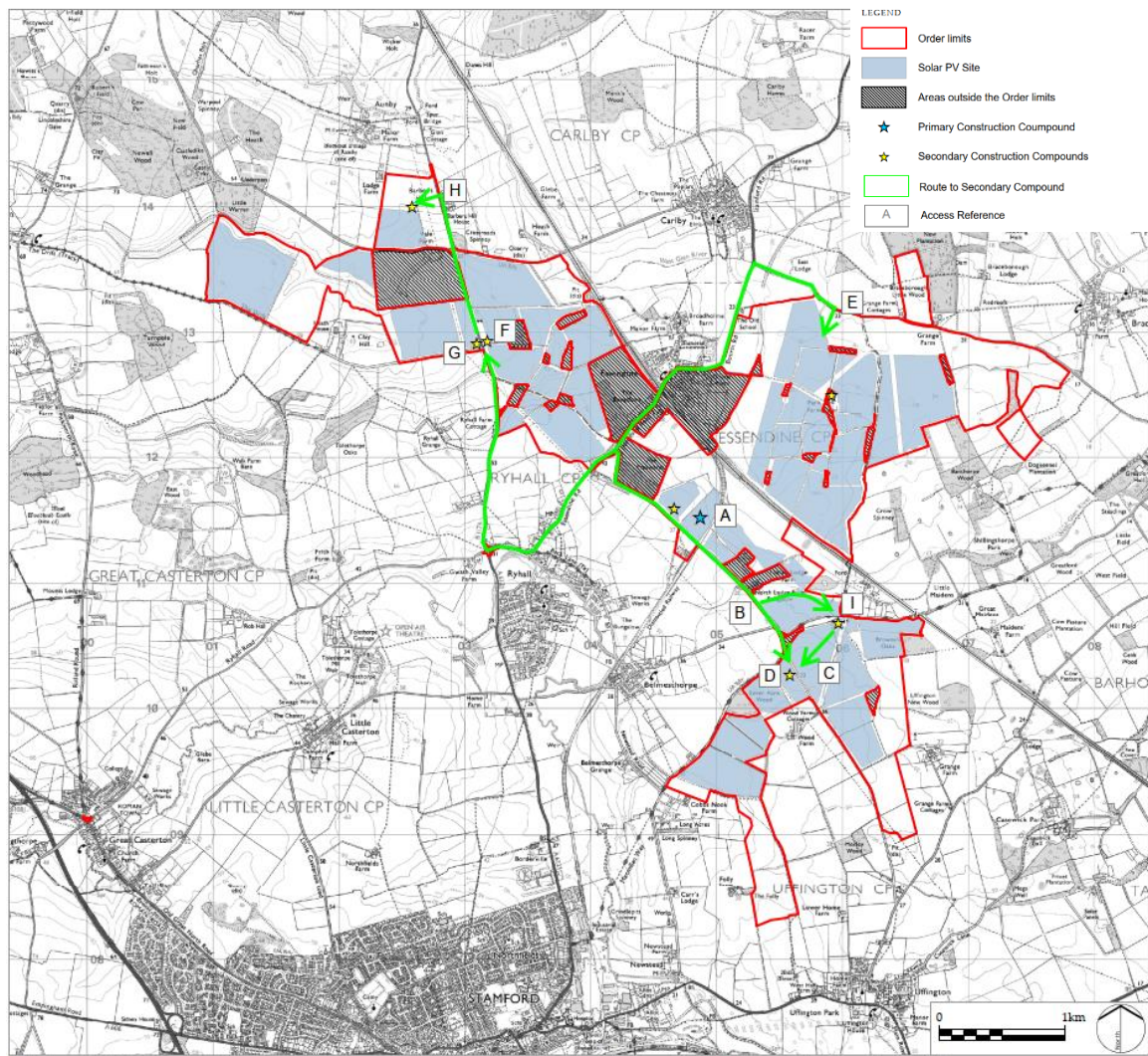

- 3.3.9 The access points that are proposed to be used for construction will be retained through the operational life cycle of the Proposed Development to enable access to the Operational Development. During the decommissioning phase and when no longer required, they will be restored back to their current arrangement.
- 3.3.10 The existing vehicle access points to the Order Limits that are not proposed to be used for access to the construction compounds will be secured (via fencing or equivalent) and will be taken out of use until the point of decommissioning.
- 3.3.11 Internal access roads will be provided within the Order Limits to minimise vehicles needing to use the LRN.
- 3.3.12 To ensure the visibility splays at the access junctions are secured and retained in perpetuity for the life cycle of the Proposed Development, a regular and cyclic maintenance regime will be secured by way of requirement on the DCO to ensure there is no obstruction to the required splays.



3.4 ABNORMAL INDIVISIBLE LOADS

- 3.4.1 The routing for the movement of Abnormal Indivisible Loads (AIL) will be agreed with the relevant key stakeholders prior to construction. At present, it is assumed that Route 1 will be utilised for the movement of all AILs to and from the SRN to the primary compound.
- 3.4.2 Should the movement of AILs be required from the primary compound to any of the other fields, the details of this will be agreed through a standalone AIL assessment prior to construction.

3.5 CABLING

- 3.5.1 As part of the construction works, there may need to be road closures required to facilitate installation of cabling.
- 3.5.2 The Traffic Regulation Measures (Temporary Road Closures) Plans set out the locations where it is considered likely that such closures would be necessary and the DCO provides that sufficient notice will be given to the police, traffic authority and the public as to when these closures are required signage and site arrangements.
- 3.5.3 The Traffic Regulation Measures (Temporary Measures) Plans also set out the locations where it is considered likely that traffic signal areas or temporary speed limits changes would be necessary to accommodate these works and the DCO provides that sufficient notice will be given to the police, traffic authority and the public as to when such areas are required.

3.6 ACCESS ROUTE SIGNAGE

- 3.6.1 Temporary signage will be erected along construction traffic routes on the LRN to provide access and routing information. These will be placed to ensure that construction vehicles and staff are able to travel directly to the Order Limits from the SRN.
- 3.6.2 Temporary signage will also be provided at key junctions within the vicinity of the Order Limits to provide warnings to other road users of the likely presence of construction vehicles and to ensure the passing bays are used correctly. This will be reinforced further through the use of banksmen to assist in navigating the passing bays.
- 3.6.3 Locations of the temporary signage will be agreed with LCC and RCC prior to implementation.

3.7 HAUL ROAD SIGNAGE

- 3.7.1 Temporary signage will also be erected along the internal haul roads during construction, providing drivers with navigational journey information e.g. distances to turnings, passing bays, or parcels, as well as warning information such as pinch points or areas where there may be vehicle conflict.

3.8 SITE WORKING HOURS

- 3.8.1 Core construction hours will run from 07:00 to 19:00 Monday to Saturday, and no working on Sundays or Bank Holidays.



- 3.8.2 Heavy Goods Vehicle (HGV) deliveries to the Order Limits and works likely to generate substantial levels of noise, aside from Horizontal Directional Drilling (HDD), would be limited to daytime hours of 07:00 to 19:00 during weekdays or Saturday mornings (until 13:00 hours), unless otherwise agreed with the relevant local authority.
- 3.8.3 In addition to the timing restrictions noted above, in order to further mitigate the impact of HGVs on local sensitive receptors including the schools within Great Casterton, HGV deliveries will be restricted to avoid school start and end time. HGVs will therefore be restricted from passing through Great Casterton any time prior to 09:00 and any time after 15:00, thus ensuring that there are no HGVs passing the schools within Great Casterton during the drop off and/or pick up periods.
- 3.8.4 HDD drilling could be required outside of the assumed day-time construction hours (i.e. evening, Sundays, Bank Holidays or at night).
- 3.8.5 Working days will be one 12-hour shift, with employees travelling to and from the Order Limits an hour either side of the 12-hour shift (i.e. between 06:00 and 07:00, and 19:00 and 20:00). Where onsite works are to be conducted outside the core working hours, this will be agreed with the relevant planning authority.
- 3.8.6 As such, it is likely that staff would arrive at the Order Limits before 07:00 and leave after 19:00 Monday to Friday and after 13:00 on a Saturday. As such, it is not expected that there would be an impact on the SRN or the LRN during traditional AM and PM peak hours.



4 MITIGATION MEASURES

4.1 OVERVIEW

- 4.1.1 This section sets out a framework for the proposed mitigation measures to be implemented as part of the final CTMP.
- 4.1.2 The full details of the mitigation measures to be implemented at the Order Limits will be provided within the final CTMP, which will be confirmed once the principal contractor is appointed.

4.2 VEHICLE IDENTIFICATION

- 4.2.1 It is anticipated that all construction vehicles associated with the Proposed Development will be clearly identifiable through the use of vehicle marking or a tracking scheme. The purpose of this is to assist with the monitoring process of the construction vehicles over the SRN and the LRN.
- 4.2.2 Only the agreed construction routes will be used for all construction vehicle access, as set out within this oCTMP.
- 4.2.3 Where protocols have not been followed or the construction routes have not been followed, unless in exceptional circumstances, the appropriate action will be taken to prevent this occurring again.

4.3 FREIGHT OPERATOR RECOGNITION SCHEMES

- 4.3.1 It is required that all transport / haulage providers of vehicles which are making journeys to the Order Limits are committed to best practice, demonstrated by membership to the Freight Operator Recognition Scheme ('FORS', or equivalent), meeting a minimum level to be agreed with the key stakeholders. The contractor will require a confirmation of accreditation from transport providers in order for approval of delivery slots, to be confirmed at the final CTMP stage.

4.4 DELIVERY TIMING

- 4.4.1 As discussed above, construction traffic movements will be scheduled to occur outside of highway network peak times.
- 4.4.2 It is anticipated that no HGV movements associated with the Proposed Development will be permitted on the LRN outside of the core working hours, unless otherwise agreed with the relevant local authority.
- 4.4.3 The above restrictions are not proposed to apply to the movements of HGVs on the SRN or as part of any AIL.
- 4.4.4 In addition to the timing restrictions noted above, in order to further mitigate the impact of HGVs on local sensitive receptors including the schools within Great Casterton, HGV deliveries will be restricted through Great Casterton to avoid school start and end times.
- 4.4.5 The contractors will be informed of the restrictions on delivery timings prior to award of the contract.



4.5 DELIVERY BOOKING

- 4.5.1 A delivery management and booking system will be used to ensure deliveries to the Order Limits will be spread across the day where possible. This booking schedule will also form part of and inform the monitoring process of the final CTMP.
- 4.5.2 Delivery timings will be carefully managed to ensure (as much as possible) that the identified delivery windows are not missed.
- 4.5.3 HGVs will be held onsite and released in a controlled manner to reduce the potential for two HGVs associated with construction of the Proposed Development to meet each other along the stretch of Uffington Lane before the A6121.
- 4.5.4 However, in the event that two HGVs need to pass each other, mitigation measures are proposed at the A6121 junction with Uffington Lane to facilitate two-way movements, as well as an indicative give way arrangement. This arrangement is presented on the plans at **APPENDIX C**.

4.6 BANKSMEN

- 4.6.1 Qualified personnel will be in place at the Order Limits access to guide construction traffic and record arrivals and departures of vehicles against the delivery schedule.

4.7 SPEED LIMIT RESTRICTIONS

- 4.7.1 It is proposed to limit the speed of construction traffic along the A6121 to 20mph in places to reduce any adverse impacts. This will be enforced through an appropriate fleet management system by the contractor, which will also be used to ensure that the agreed construction routes are adhered to.
- 4.7.2 The Traffic Regulation Measures (Temporary Measures) Plans set out the locations where it is considered likely that speed limit restrictions would be necessary and the DCO provides that sufficient notice will be given to the police, traffic authority and the public as to when such restrictions are required. Internally within the Order Limits, there will be a maximum-speed-limit of 15mph on surfaced and 10mph on un-surfaced haul roads and work areas.

4.8 INCIDENT MANAGEMENT PLAN

- 4.8.1 An incident management plan (IMP) will be prepared for inclusion in the final CTMP to set out the procedures should any parts of the LRN, or SRN be impacted by the Proposed Development.

4.9 CLEANING OF VEHICLES

- 4.9.1 All of the Order Limits access points will incorporate a wheel washing system, with rumble grids to dislodge accumulated dust and mud prior to all vehicles leaving the Order Limits, where reasonably practicable.

4.10 HIGHWAY CONDITION SURVEYS

- 4.10.1 Highway condition surveys will be undertaken both before and after construction. The scope of the condition surveys is to be agreed with the local highway authorities in advance of construction with the principle that the Applicant will restore any damaged highways as a result of its construction traffic movements to the standard set out in the pre-construction surveys.



4.11 TEMPORARY TRAFFIC MANAGEMENT PROCEDURES

- 4.11.1 Temporary Traffic Management Procedures (TTM) may be required to enhance safety conditions on the LRN and mitigate potential impacts of the construction traffic.
- 4.11.2 The Traffic Regulation Measures (Temporary Measures) Plans set out the locations where it is considered likely that traffic signal areas or temporary speed limits changes would be necessary and the DCO provides that sufficient notice will be given to the police, traffic authority and the public as to when such areas are required.
- 4.11.3 The works may also include temporary road closures, which are outlined within the Traffic Regulation Measures (Temporary Road Closures) Plans, in order to enable the installation of cabling. The full details of all TTM will be detailed within the final CTMP once the scope of the works is confirmed by the principal contractor.
- 4.11.4 Discussions on the requirement and scope of any other TTM are ongoing and will be agreed with the relevant local traffic authority prior to the commencement of construction.

4.12 OUTLINE TRAVEL PLAN

- 4.12.1 An outline Travel Plan (TP) will be implemented for the Proposed Development which will set out a number of travel planning initiatives including:
- Travel planning awareness
 - Details of the Travel Plan Co-ordinator (TPC)
 - Details on the shuttle bus for staff
 - Details of staff car parking arrangements
 - Car sharing initiatives
 - Modal shift monitoring
 - Mechanisms to monitor, review and update the Travel Plan
- 4.12.2 The outline TP is provided in **APPENDIX G** to this oCTMP and will be updated and presented as part of the Final CTMP submitted prior to construction.

4.13 INFORMATION, COMMUNICATION PACKS AND AWARENESS

- 4.13.1 Information packs will be provided to all contractors which will form part of the contractual agreement between the contractors and the Applicant, who will be briefed on the contents. The information packs would include information on the agreed construction routes, the delivery procedures and Order Limits protocols in the event of any incidents.

4.14 ABNORMAL INDIVISIBLE LOADS

- 4.14.1 Where AIL movements are required, all AIL vehicles will be escorted by a pilot and police car, with the timings being agreed with the Police, National Highways and the relevant local authorities. It is assumed this will take place outside of peak hours and/or during the night.



- 4.14.2 The local communities affected by the delivery of the AILs will be contacted prior to any movements taking place. It is envisaged that this will include leaflet drops and publication in the local press advising of the AIL movements.



5 IMPLEMENTING, MONITORING AND REVIEW

5.1 OVERVIEW

5.1.1 This section reviews the measures for the implementation, monitoring and review that will be incorporated into the final CTMP.

5.2 IMPLEMENTATION

5.2.1 An individual will be appointed who will oversee the final CTMP and act as a point of contact for all key stakeholders, acting as the Transport Coordination Officer (TCO). The TCO will be responsible for monitoring the final CTMP and ensuring that the mitigation measures are sufficient. Where the mitigation is not deemed to be sufficient, the TCO will seek to implement remedial measures to mitigate any issues.

5.2.2 The Applicant will ensure there are sufficient funds for the TCO to fulfil their role.

TRAFFIC MANAGEMENT WORKING GROUP

5.2.3 The TCO will report all findings of the aforementioned to the Traffic Management Working Group (TMWG). The TMWG will consist of, but not be limited to, the following:

- National Highways
- Rutland County Council
- Lincolnshire County Council
- South Kesteven District Council
- Great Casterton Primary School and Great Casterton College
- Essendine Parish Council
- Ryhall and Belmesthorpe Parish Council
- Stamford Town Council
- Great Casterton Parish Council
- Carlby Parish Council
- Careby with Aunby and Holywell Parish Council
- Langtoft Parish Council
- Greatford Parish Council
- Braceborough and Wilsthorpe Parish Council

5.2.4 The TMWG will meet to discuss and review the traffic and transportation elements on the construction phase of the Proposed Development. The meetings will be scheduled at an agreed frequency to be set out within the final CTMP, allowing for meetings in the event of specific issues being raised and brought to the attention of the TCO.

5.2.5 The role of the TMWG will be to discuss and review the mitigation measures proposed in the final CTMP. The TMWG will also be able to suggest remedial changes to the construction transportation strategy if required.



5.3 COMPLIANCE

- 5.3.1 The measures set out within the final CTMP will be specified within the principal contractor's contract. Where these measures are not followed, or concerns are raised through the TMWG, the contract of the principal contractor could be reviewed.
- 5.3.2 The Applicant will set out in the final CTMP a complaints protocol.



APPENDIX A

ORDER LIMITS



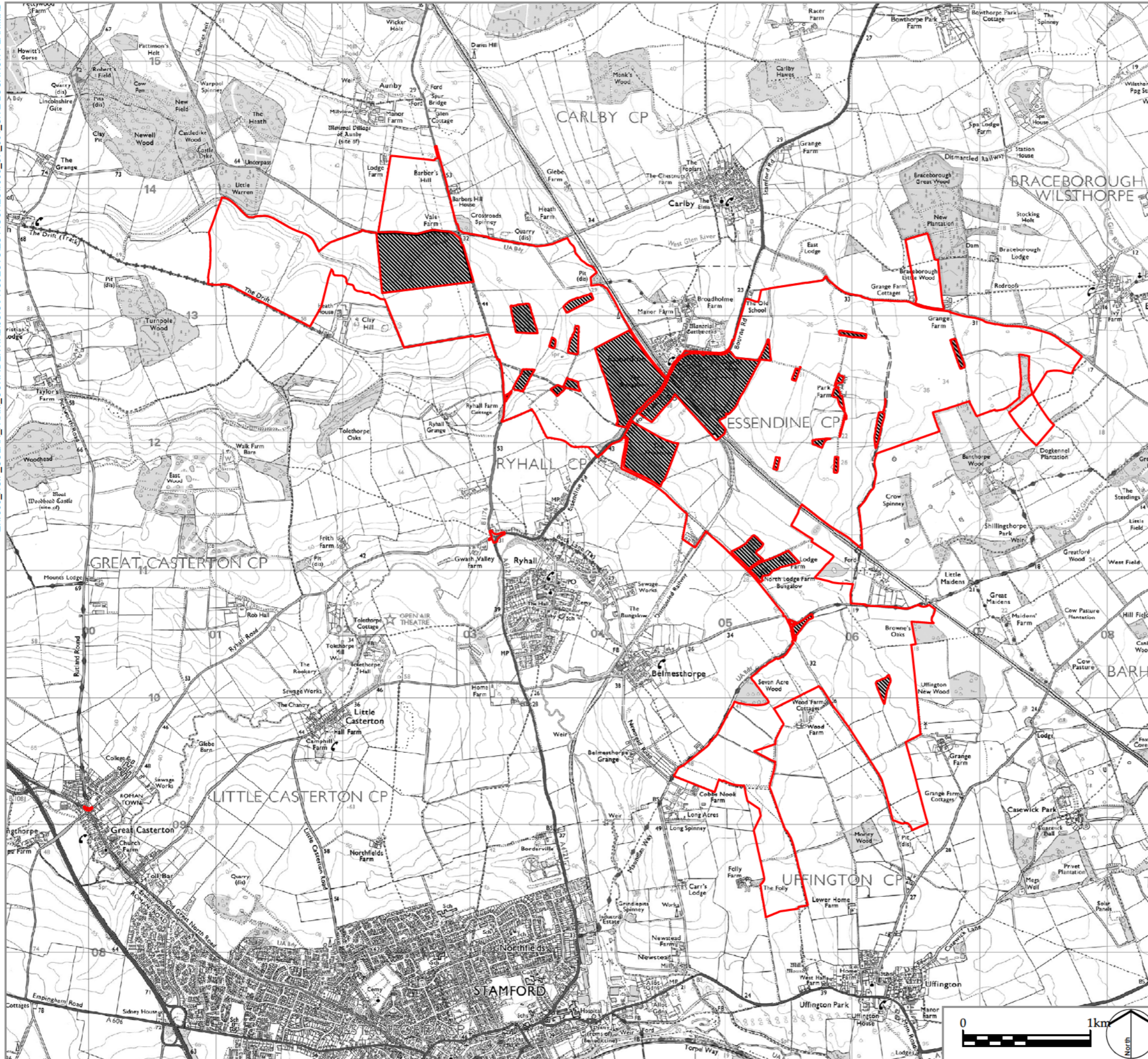

Infrastructure Planning (Applications:
Prescribed Forms and Procedure) Regulations 2009
APFP Regulation: 5(2)(a)

PINS REFERENCE NUMBER
EN010127

LEGEND

- Order Limits
- Areas outside the Order limits

P0 DCO Submission
REV. DESCRIPTION

RP 06/11/22
APP. DATE



PROJECT TITLE
MALLARD PASS SOLAR FARM

DRAWING TITLE
Figure 1.1: Order limits

| | | |
|-----------|----------|-----------------|
| ISSUED BY | Oxford | T: 01865 887050 |
| DATE | Nov 2022 | DRAWN AG |
| SCALE @A3 | 1:30,000 | CHECKED PD |
| STATUS | Final | APPROVED RP |

DWG. NO. 7863_SK_601 REV: P0

No dimensions are to be scaled from this drawing.
All dimensions are to be checked on site.
Area measurements for indicative purposes only.

© LDA Design Consulting Ltd. Quality Assured to BS EN ISO 9001 : 2015

Sources: Ordnance Survey

APPENDIX B

CONSTRUCTION COMPOUND OVERVIEW



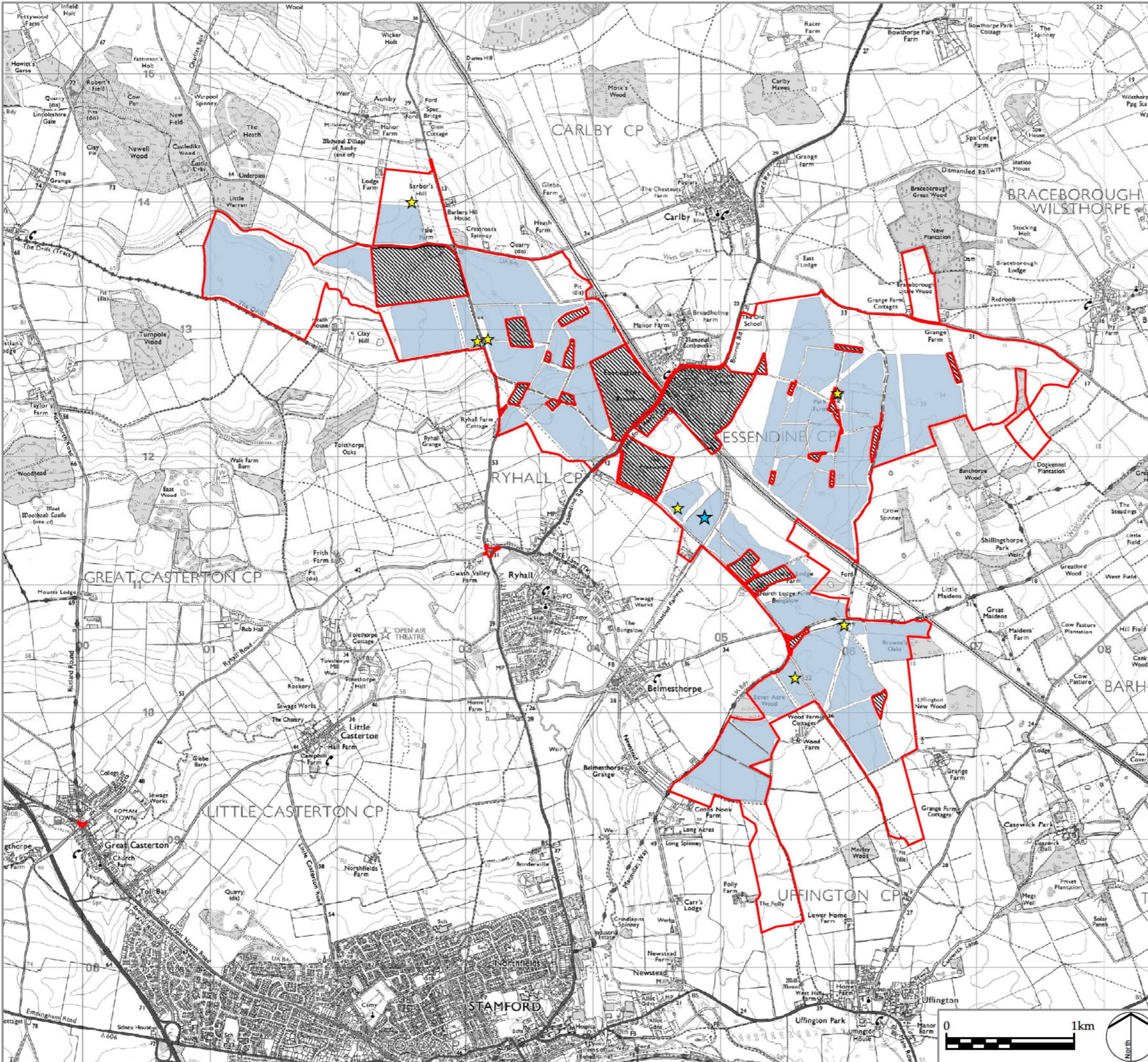





Infrastructure Planning (Applications:
Prescribed Forms and Procedure) Regulations 2009
APFP Regulation: 5(2)(a)

PINS REFERENCE NUMBER
EN010127

LEGEND

-  Order limits
-  Solar PV Site
-  Areas outside the Order limits
-  Primary Construction Compound
-  Secondary Construction Compounds

P0 DCO Submission
REV. DESCRIPTION

RP 06/11/22
APP. DATE



PROJECT TITLE
MALLARD PASS SOLAR FARM

DRAWING TITLE
Appendix B - Construction Compound Overview

| | | |
|-----------|----------|-----------------|
| ISSUED BY | Oxford | T: 01865 887050 |
| DATE | Nov 2022 | DRAWN AG |
| SCALE @A3 | 1:30,000 | CHECKED PD |
| STATUS | Final | APPROVED RP |

DWG. NO. Appendix B REV: P0

No dimensions are to be scaled from this drawing.
All dimensions are to be checked on site.
Area measurements for indicative purposes only.

© LDA Design Consulting Ltd. Quality Assured to BS EN ISO 9001 : 2015

Sources: Ordnance Survey

APPENDIX C

A1621 ESSENDINE ROAD / UFFINGTON LANE WORKS



X:\LDA_4990\2002_MALLARD PASS SOLAR FARM\CAD\1.0_CURRENT\1.0.1_SHEETS\4990-2001-T-024-033-D - ACCESS ARRANGEMENT DETAILS.DWG

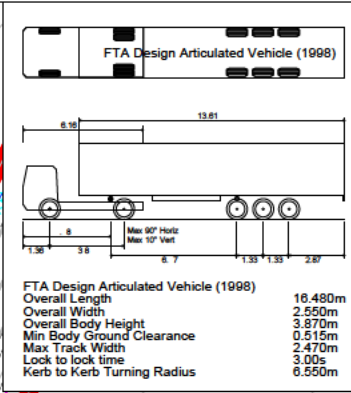
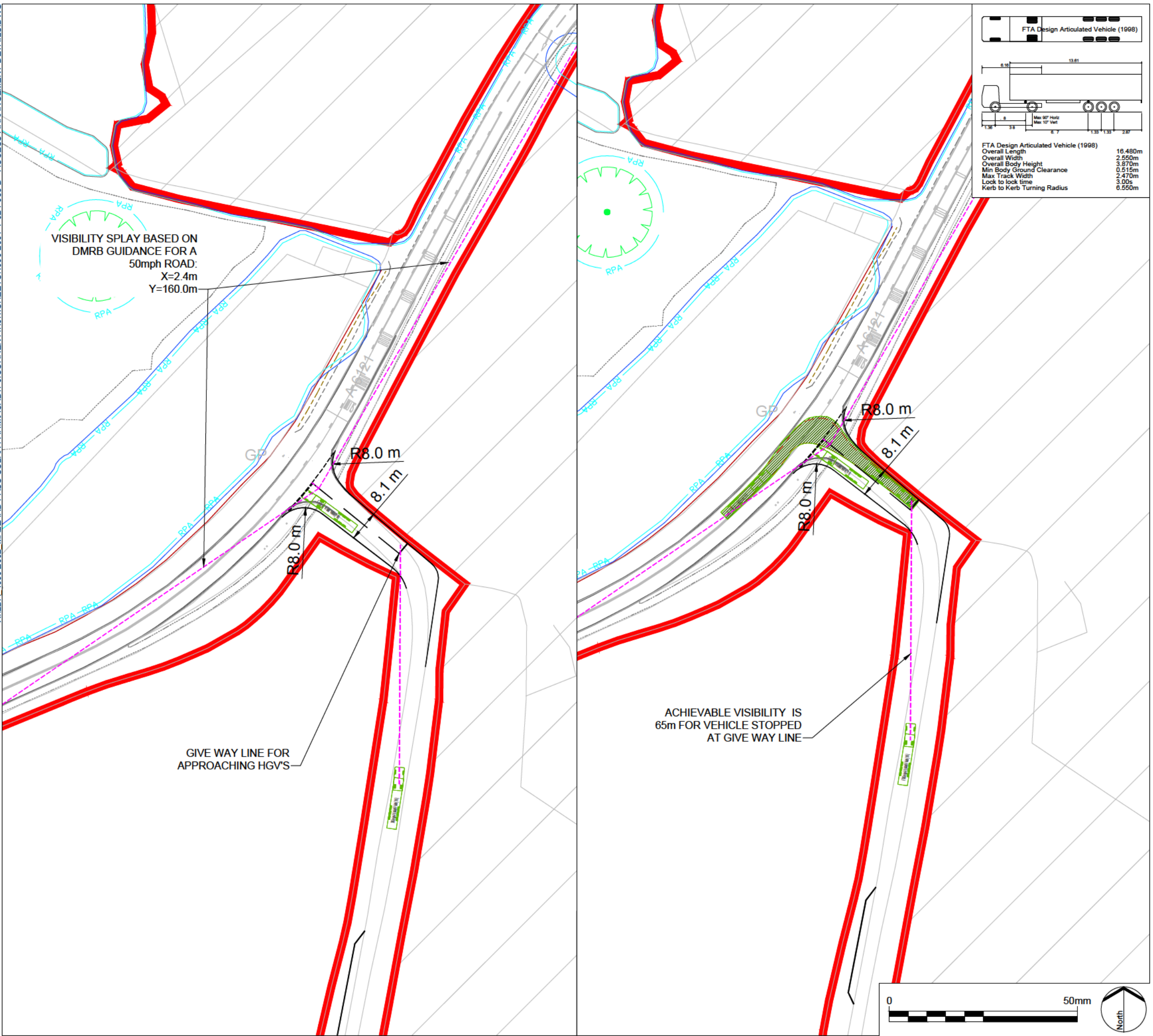

VISIBILITY SPLAY BASED ON DMRB GUIDANCE FOR A 50mph ROAD:
X=2.4m
Y=160.0m

GIVE WAY LINE FOR APPROACHING HGVS

ACHIEVABLE VISIBILITY IS 65m FOR VEHICLE STOPPED AT GIVE WAY LINE

LEGEND

- Order limits
- Areas outside of Order limits
- Access Visibility Splay

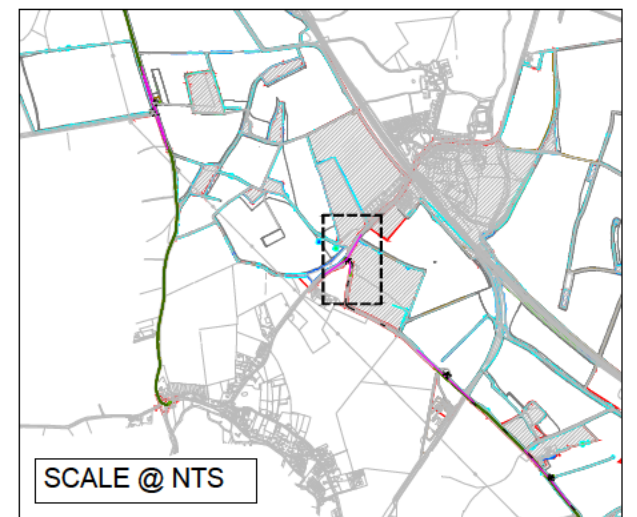

| REV. | DESCRIPTION | APP. DATE |
|------|-------------|-----------|
|------|-------------|-----------|

LD A DESIGN

PROJECT TITLE
MALLARD PASS SOLAR FARM
OUTLINE CONSTRUCTION MANAGEMENT PLAN

DRAWING TITLE
ESSENDINE A6121/ UFFINGTON LANE
SITE ACCESS JUNCTION - SWEEP PATH
ANALYSIS

| | | |
|-----------|----------|------------------|
| ISSUED BY | Oxford | T: 01865 887 050 |
| DATE | 04/03/22 | DRAWN GSF |
| SCALE@A3 | 1:1 | CHECKED CR |
| STATUS | Sketch | APPROVED MK |

DWG. NO 4990-2001-T-032-D

No dimensions are to be scaled from this drawing.
All dimensions are to be checked on site.
Area measurements for indicative purposes only.

© LDA Design Consulting Ltd. Quality Assured to BS EN ISO 9001 : 2015

Sources Ordnance Survey



APPENDIX D

PROPOSED PRIMARY COMPOUND ACCESS



C:\USERS\GFLETCHER\PIVTP - CAD\DA_4990\2002_MALLARD PASS SOLAR FARM\CAD\1.0.1.SHEETS\4990-2001-T-024-033-D - ACCESS ARRANGEMENT DETAILS.DWG

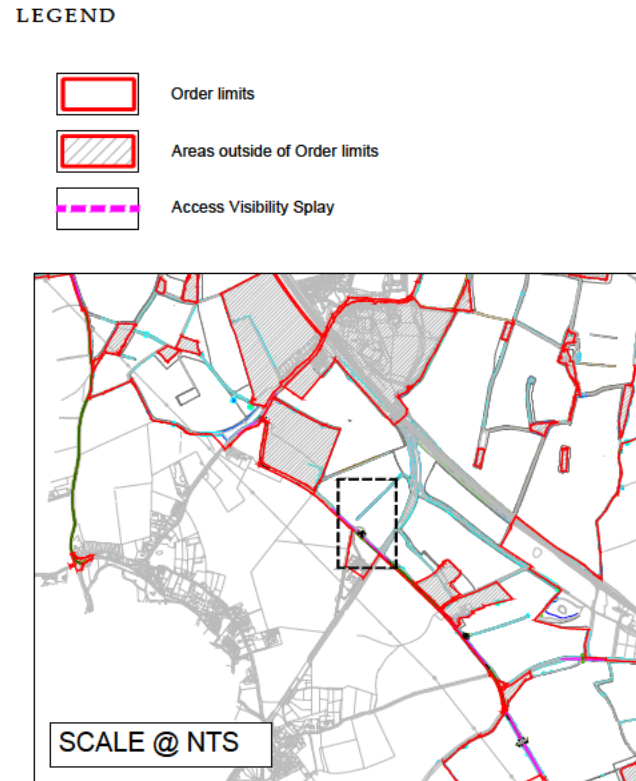
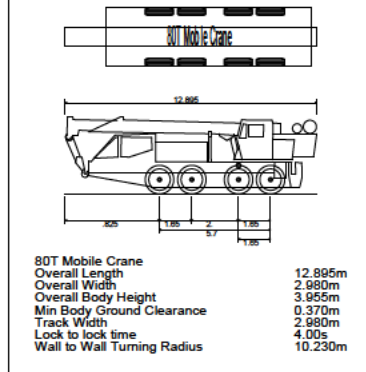
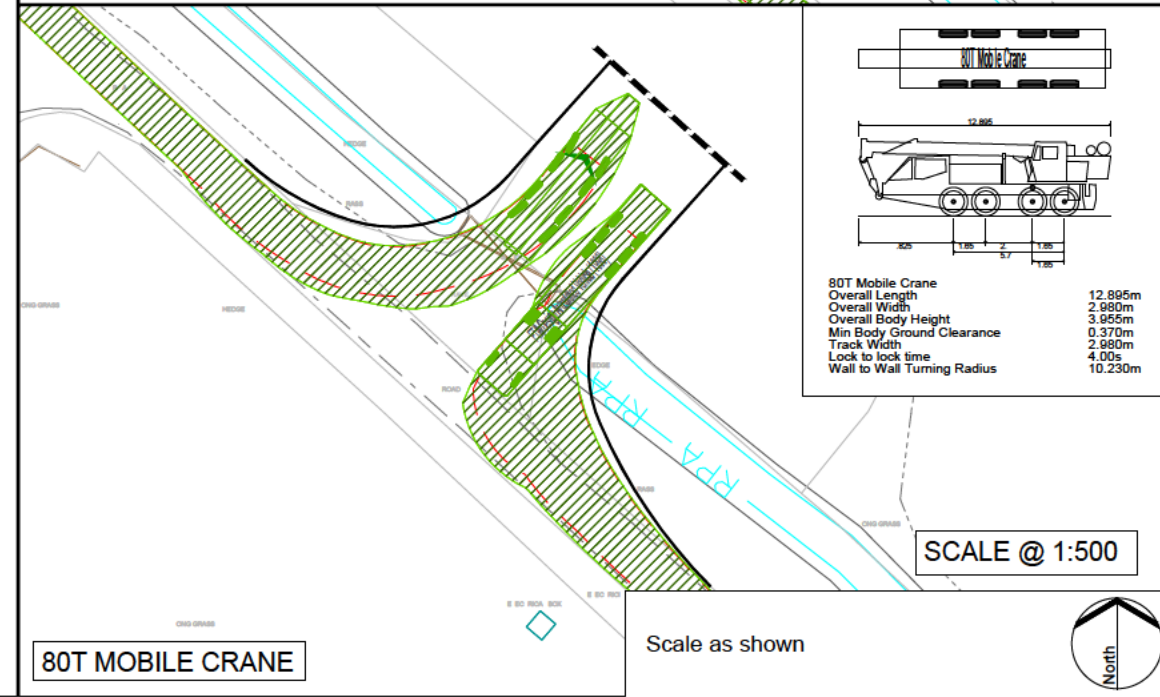
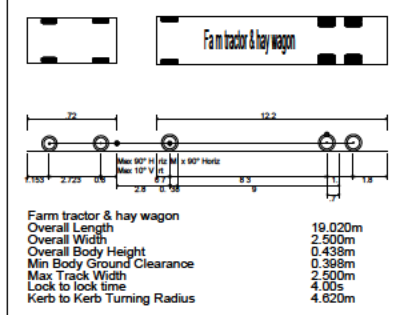
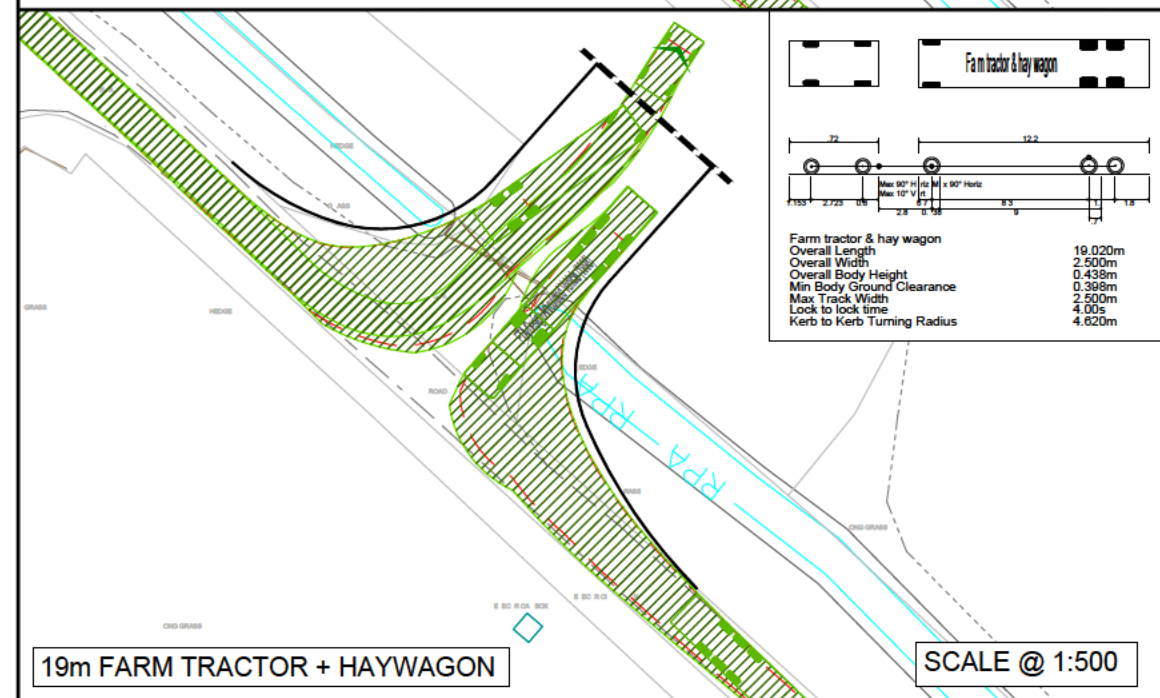
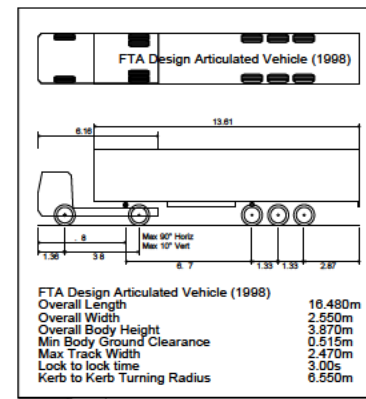
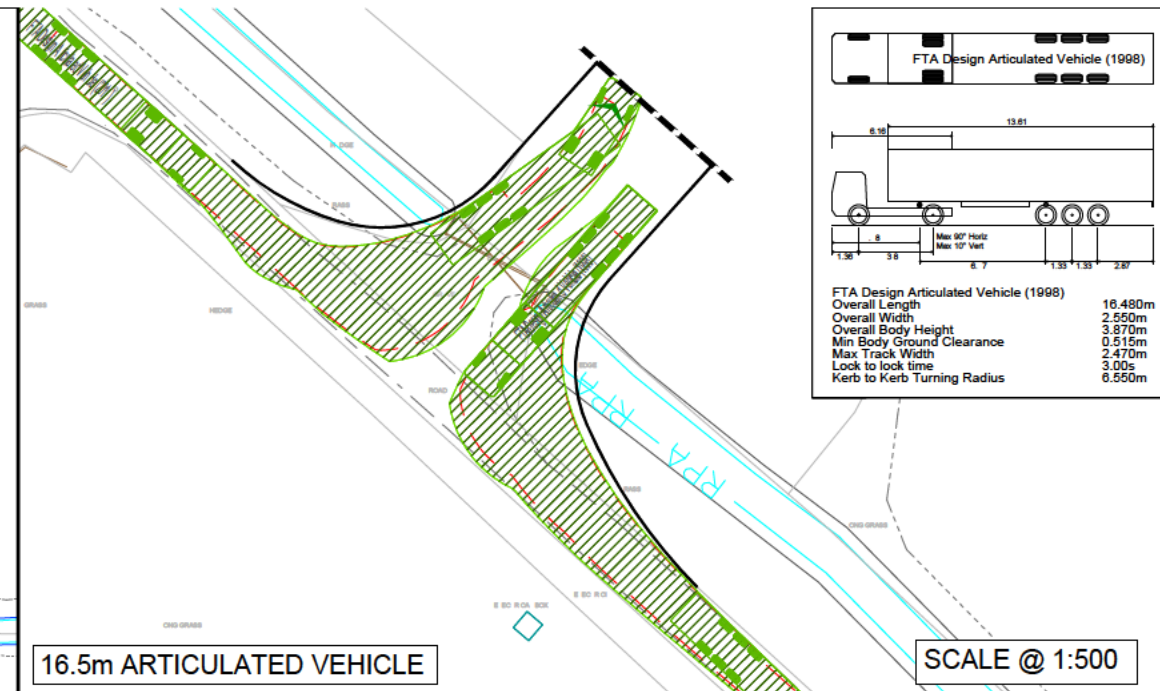
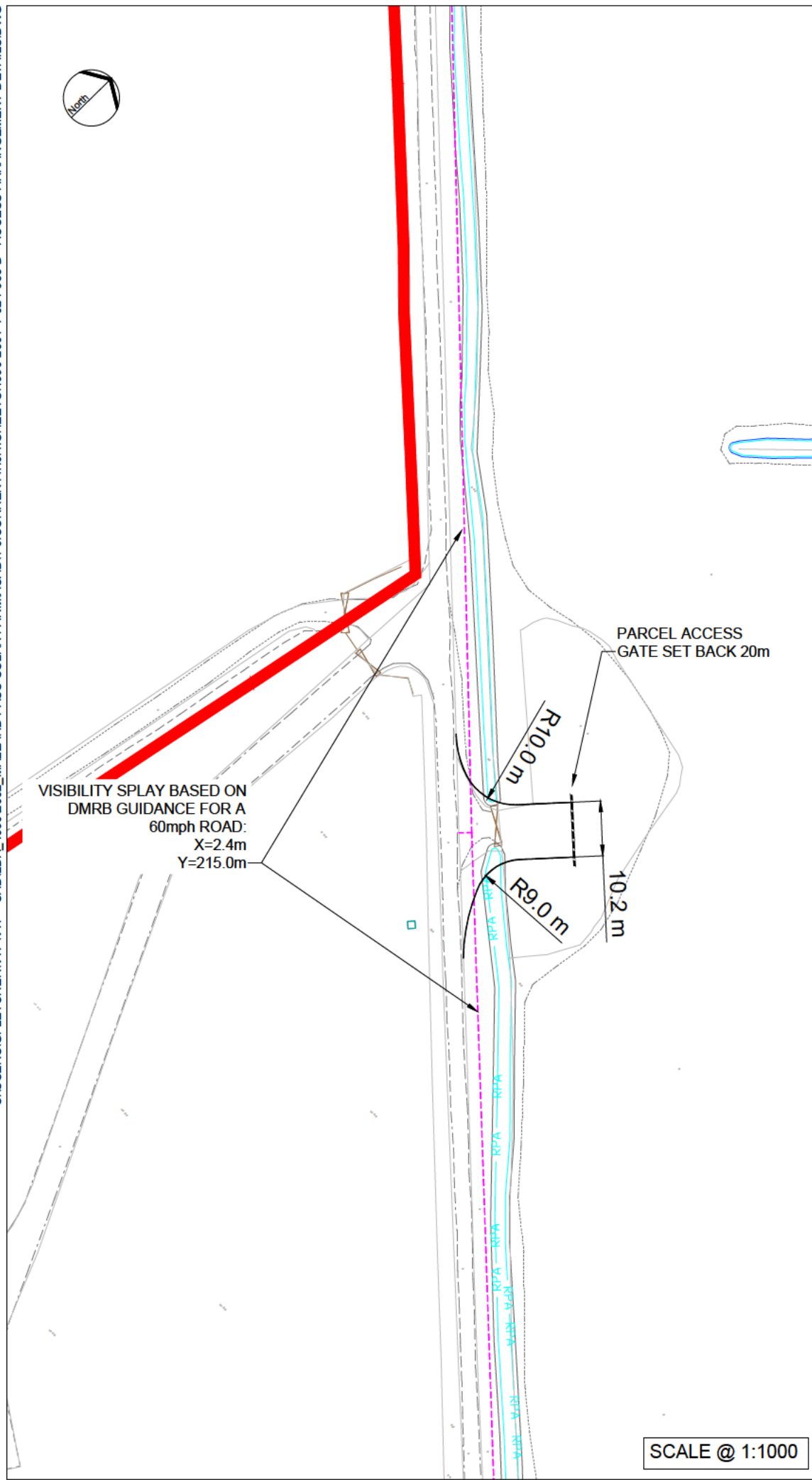

| REV. | DESCRIPTION | APP. DATE |
|------|-------------|-----------|
|------|-------------|-----------|

LD A DESIGN

PROJECT TITLE
MALLARD PASS SOLAR FARM
OUTLINE CONSTRUCTION MANAGEMENT PLAN

DRAWING TITLE
ACCESS A
SITE ACCESS JUNCTION - SWEEP
PATH ANALYSIS

| | | |
|-----------|----------|------------------|
| ISSUED BY | Oxford | T: 01865 887 050 |
| DATE | 04/03/22 | DRAWN GSF |
| SCALE@A3 | As shown | CHECKED CR |
| STATUS | Sketch | APPROVED MK |

DWG. NO 4990-2001-T-027-D

No dimensions are to be scaled from this drawing.
All dimensions are to be checked on site.
Area measurements for indicative purposes only.

© LDA Design Consulting Ltd. Quality Assured to BS EN ISO 9001 : 2015
Sources Ordnance Survey

APPENDIX E

ACCESS FROM PRIMARY TO SECONDARY COMPOUND



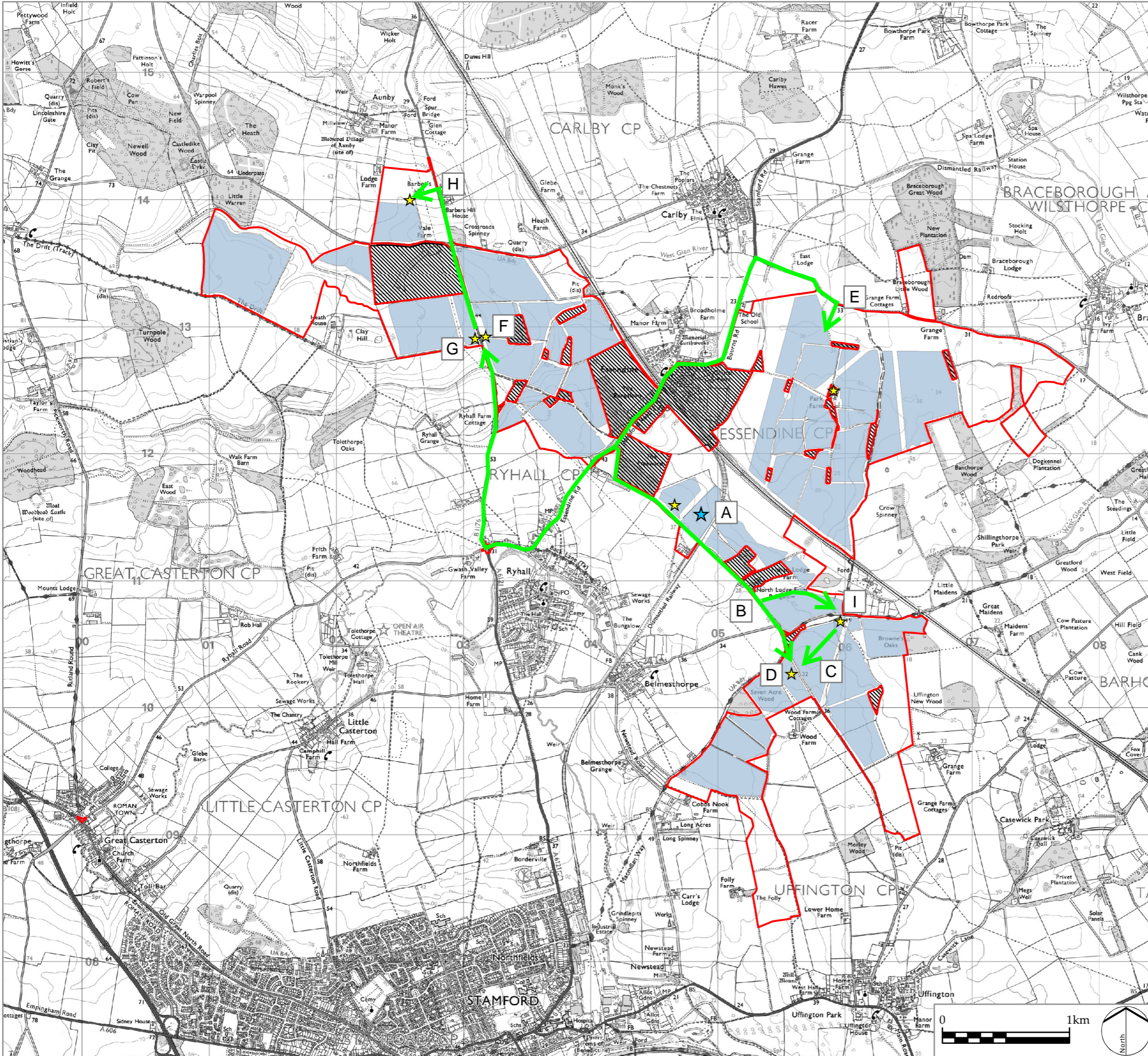







Infrastructure Planning (Applications: Prescribed Forms and Procedure) Regulations 2009 APFP Regulation: 5(2)(a)

PINS REFERENCE NUMBER
EN010127

LEGEND

-  Order limits
-  Solar PV Site
-  Areas outside the Order limits
-  Primary Construction Compound
-  Secondary Construction Compounds
-  Route to Secondary Compound
-  Access Reference

P1 Examination
P0 DCO Submission
REV. DESCRIPTION

RP 24/05/23
RP 06/11/22
APP. DATE



PROJECT TITLE
MALLARD PASS SOLAR FARM

DRAWING TITLE
Appendix E: Routes from Primary Compound to Secondary Compound.

ISSUED BY Oxford T: 01865 887050
DATE Nov 2022 DRAWN AG
SCALE @A3 1:30,000 CHECKED PD
STATUS Final APPROVED RP

DWG. NO. Appendix E REV: P1

No dimensions are to be scaled from this drawing.
All dimensions are to be checked on site.
Area measurements for indicative purposes only.

© LDA Design Consulting Ltd. Quality Assured to BS EN ISO 9001 : 2015

Sources: Ordnance Survey

APPENDIX F

SWEPT PATH ANALYSIS





VISIBILITY SPLAY BASED ON
DMRB GUIDANCE FOR A
60mph ROAD:
X=2.4m
Y=215.0m

PARCEL ACCESS
GATE SET BACK 20m

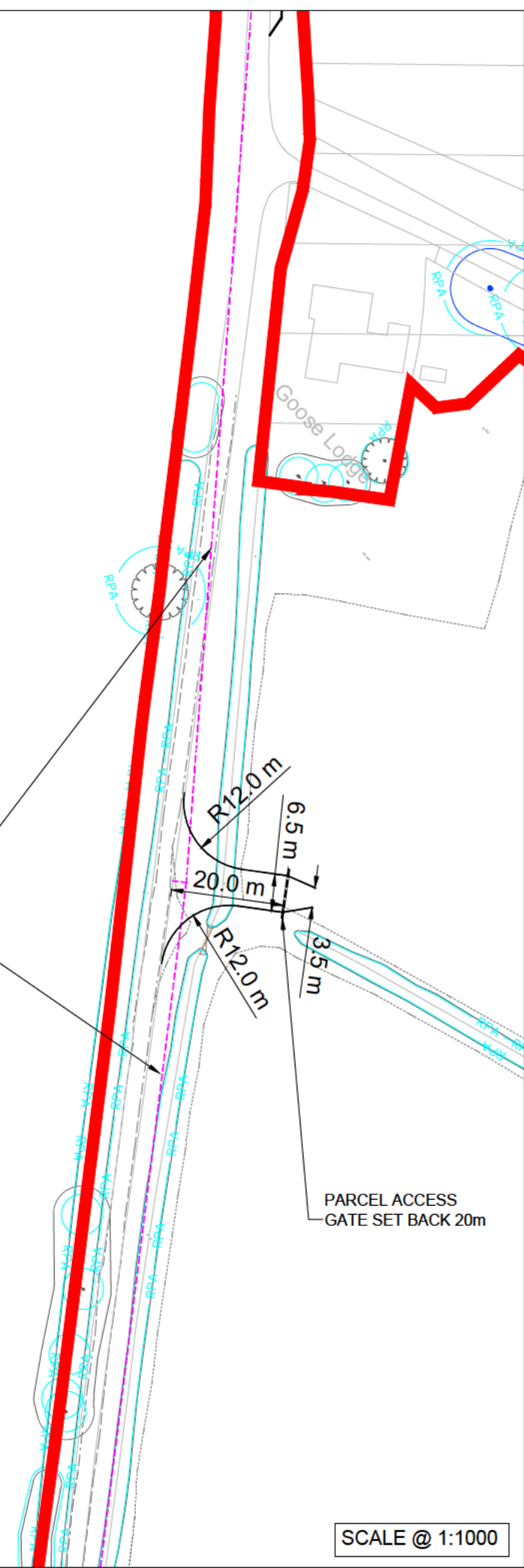

16.5m ARTICULATED VEHICLE

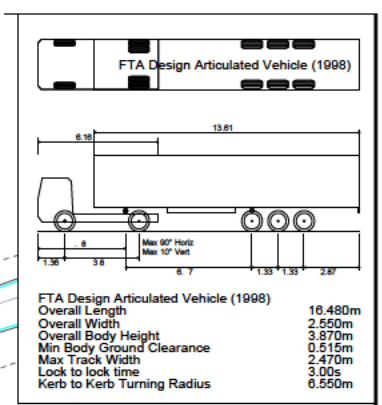

SCALE @ 1:500

19m FARM TRACTOR + HAYWAGON

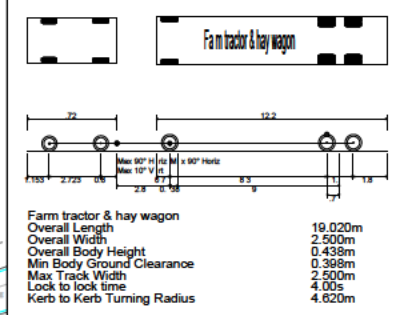

SCALE @ 1:500

80T MOBILE CRANE

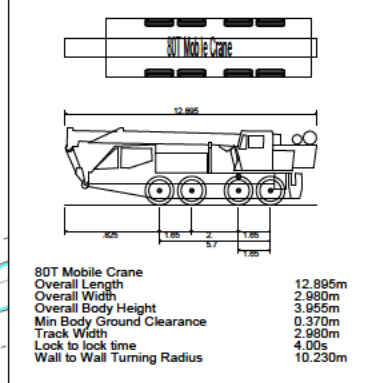

SCALE @ 1:500

Scale as shown

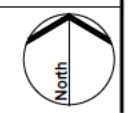

LEGEND

- Order limits
- Areas outside of Order limits
- Access Visibility Splay

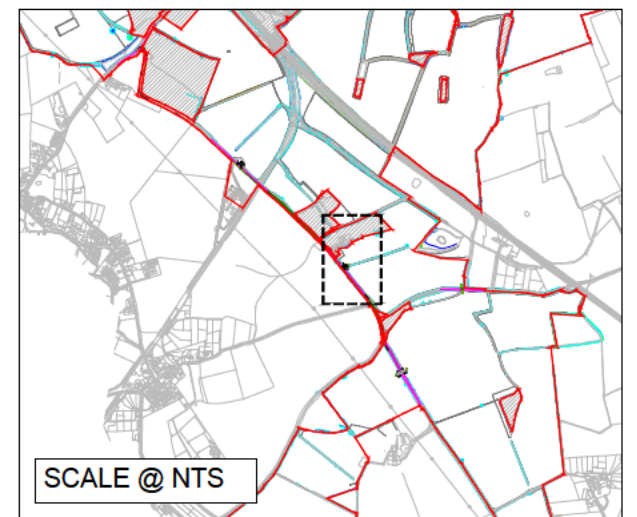

| REV. | DESCRIPTION | APP. DATE |
|------|-------------|-----------|
|------|-------------|-----------|

LD A DESIGN

PROJECT TITLE
MALLARD PASS SOLAR FARM
OUTLINE CONSTRUCTION MANAGEMENT PLAN

DRAWING TITLE
ACCESS B
SITE ACCESS JUNCTION - SWEEP
PATH ANALYSIS

| | | |
|-----------|----------|------------------|
| ISSUED BY | Oxford | T: 01865 887 050 |
| DATE | 04/03/22 | DRAWN GSF |
| SCALE@A3 | As shown | CHECKED CR |
| STATUS | Sketch | APPROVED MK |

DWG. NO 4990-2001-T-028-D

No dimensions are to be scaled from this drawing.
All dimensions are to be checked on site.
Area measurements for indicative purposes only.

© LDA Design Consulting Ltd. Quality Assured to BS EN ISO 9001 : 2015

Sources Ordnance Survey

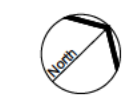

VISIBILITY SPLAY BASED ON
DMRB GUIDANCE FOR A
60mph ROAD:
X=2.4m
Y=215.0m

PARCEL ACCESS
GATE SET BACK 20m

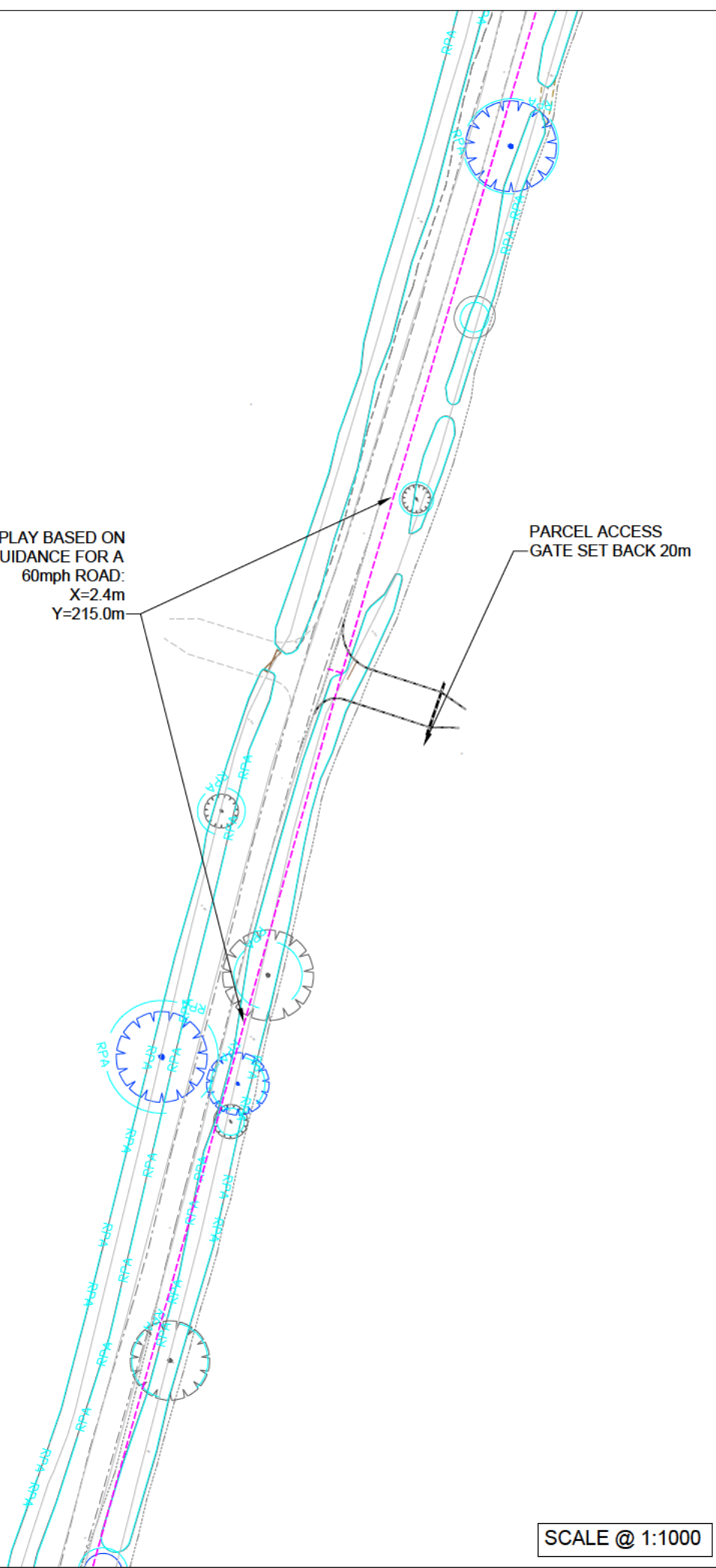

SCALE @ 1:1000

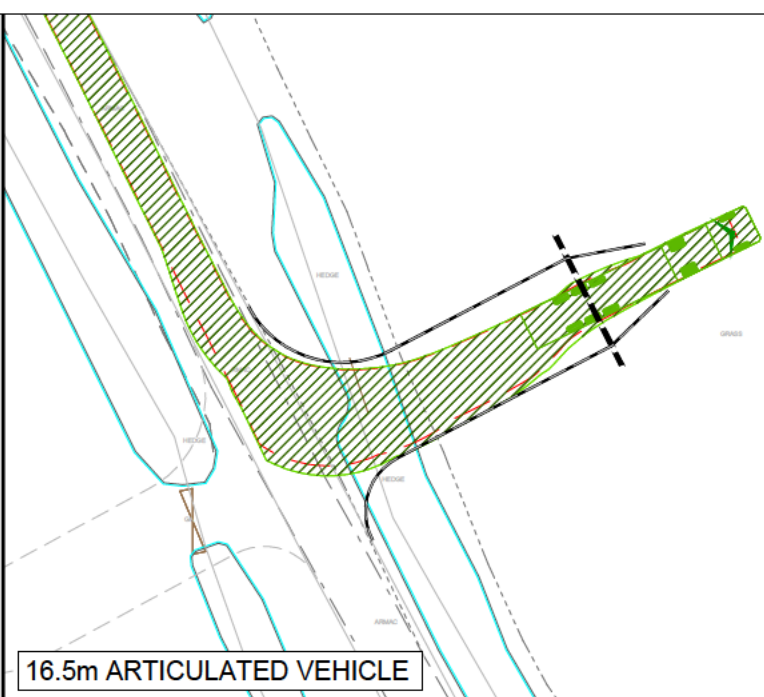

16.5m ARTICULATED VEHICLE

SCALE @ 1:500

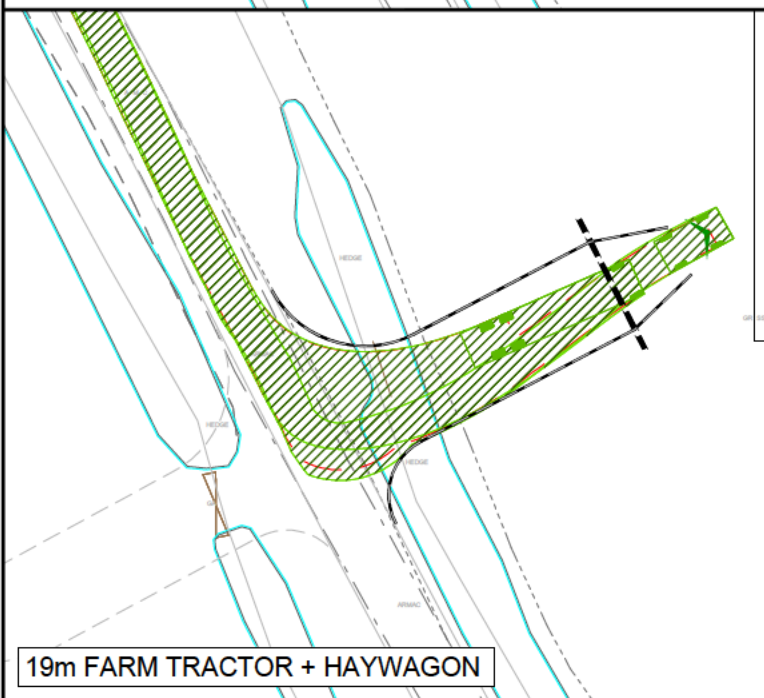
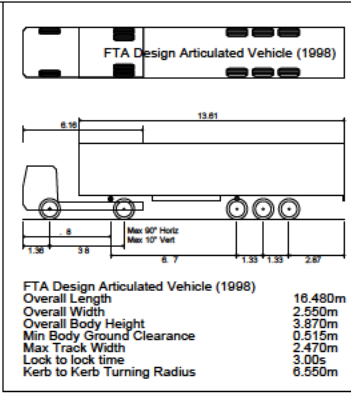

19m FARM TRACTOR + HAYWAGON

SCALE @ 1:500

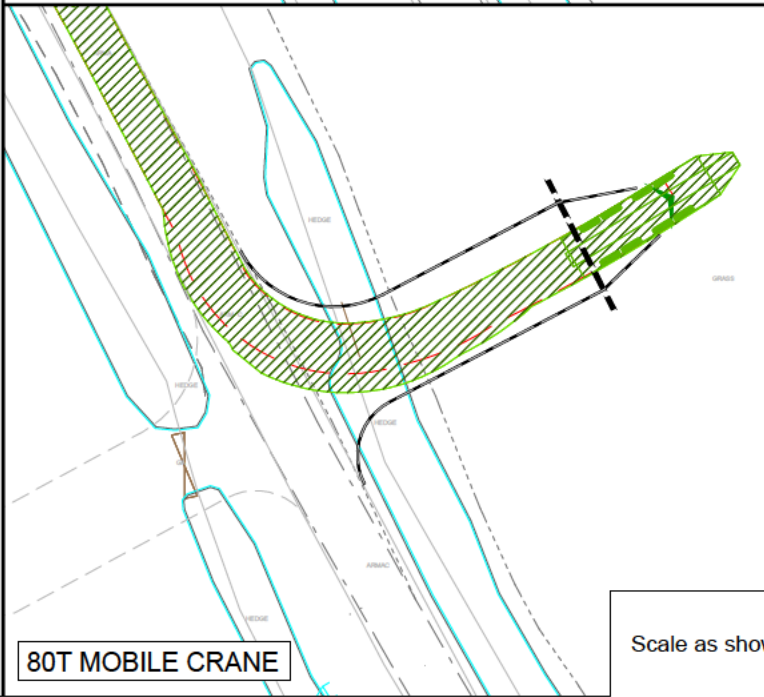
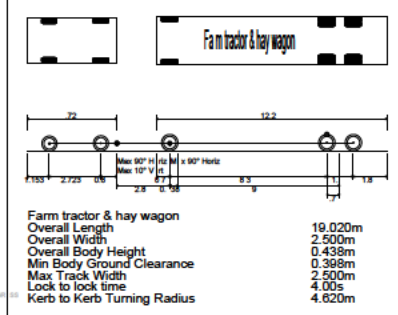

80T MOBILE CRANE

SCALE @ 1:500

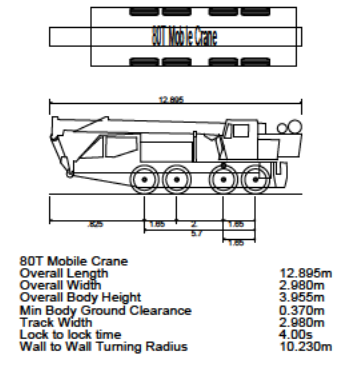

Scale as shown

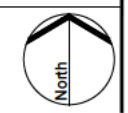

LEGEND

- Order limits
- Areas outside of Order limits
- Access Visibility Splay

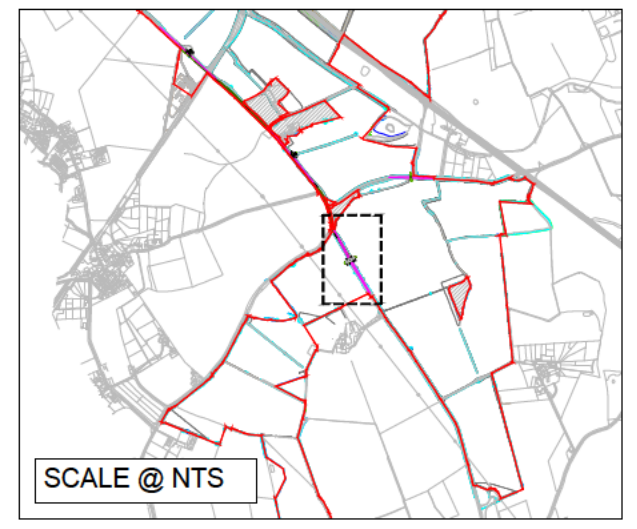

SCALE @ NTS

| REV. | DESCRIPTION | APP. | DATE |
|------|-------------|------|------|
| | | | |

LD A DESIGN

PROJECT TITLE
MALLARD PASS SOLAR FARM
OUTLINE CONSTRUCTION MANAGEMENT PLAN

DRAWING TITLE
ACCESS C
SITE ACCESS JUNCTION - SWEEP
PATH ANALYSIS

| | | |
|-----------|----------|------------------|
| ISSUED BY | Oxford | T: 01865 887 050 |
| DATE | 04/03/22 | DRAWN GSF |
| SCALE@A3 | As shown | CHECKED CR |
| STATUS | Sketch | APPROVED MK |

DWG. NO 4990-2001-T-031-D

No dimensions are to be scaled from this drawing.
All dimensions are to be checked on site.
Area measurements for indicative purposes only.

© LDA Design Consulting Ltd. Quality Assured to BS EN ISO 9001 : 2015

Sources Ordnance Survey

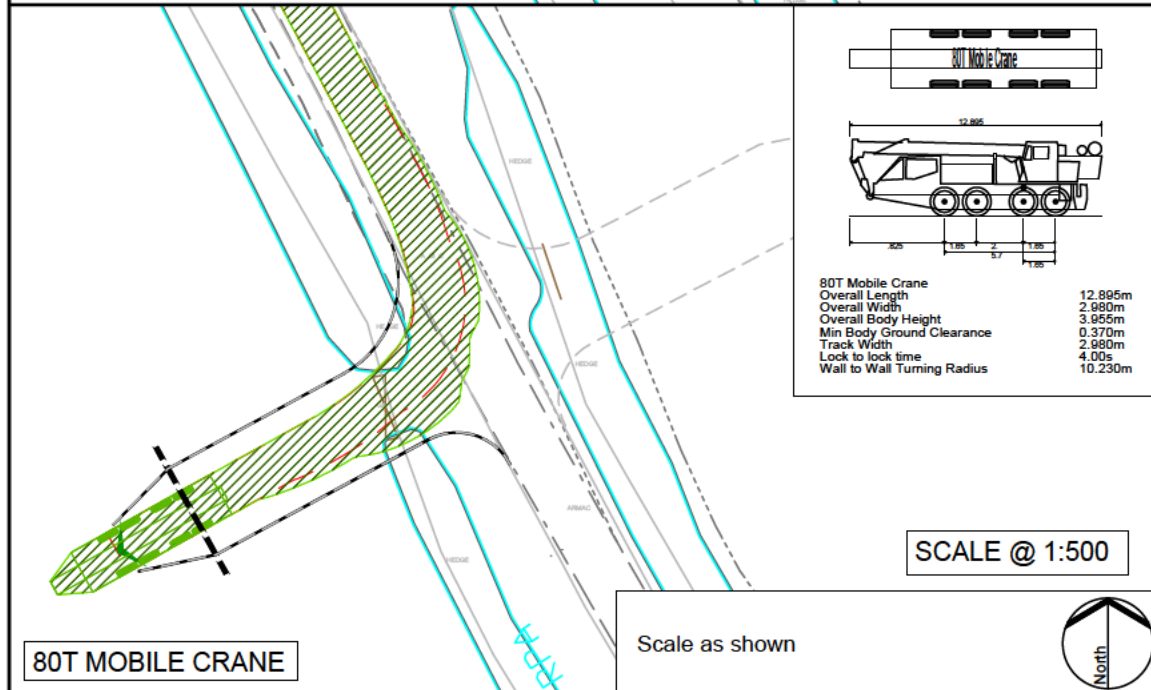
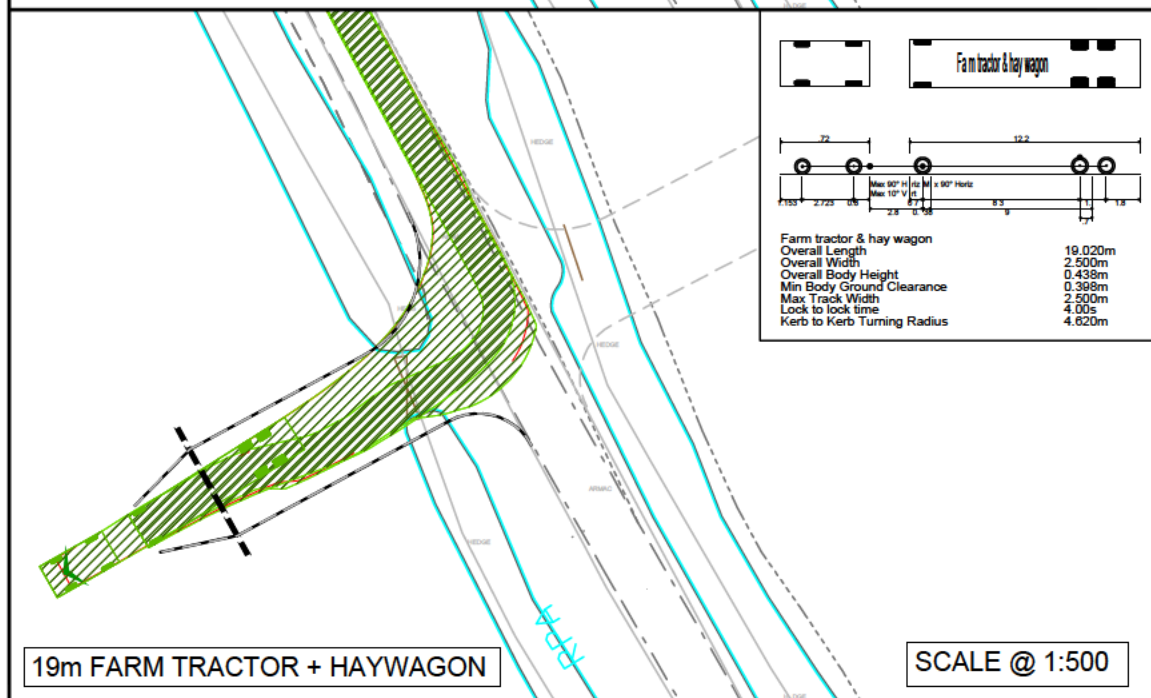
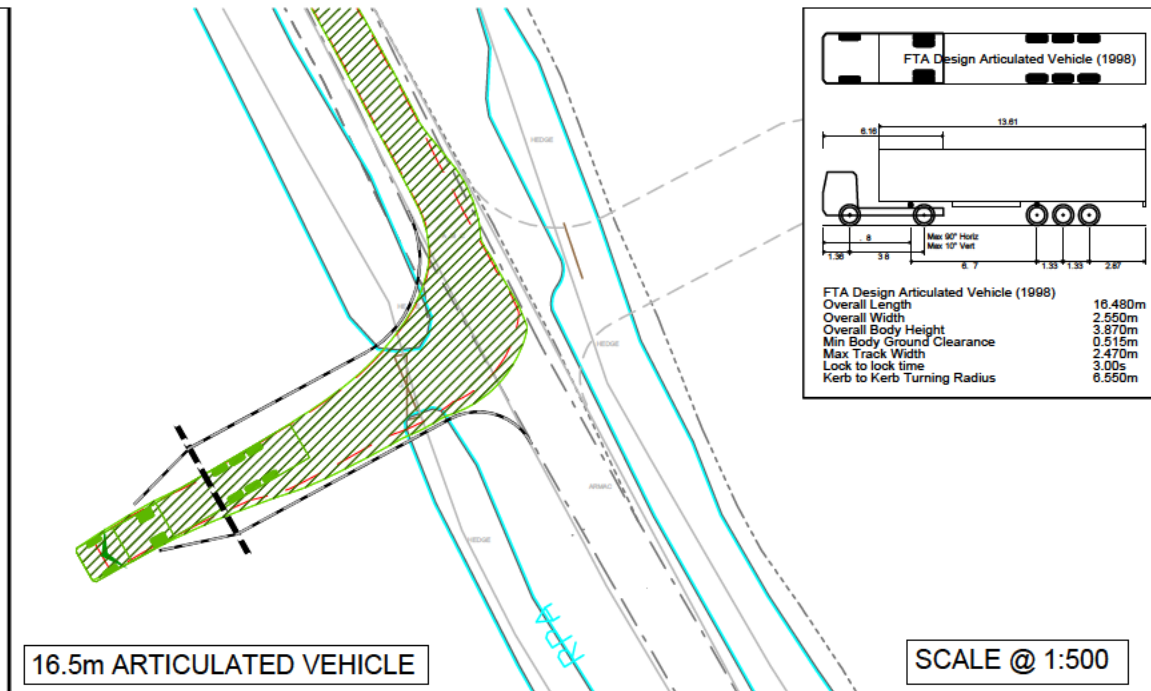
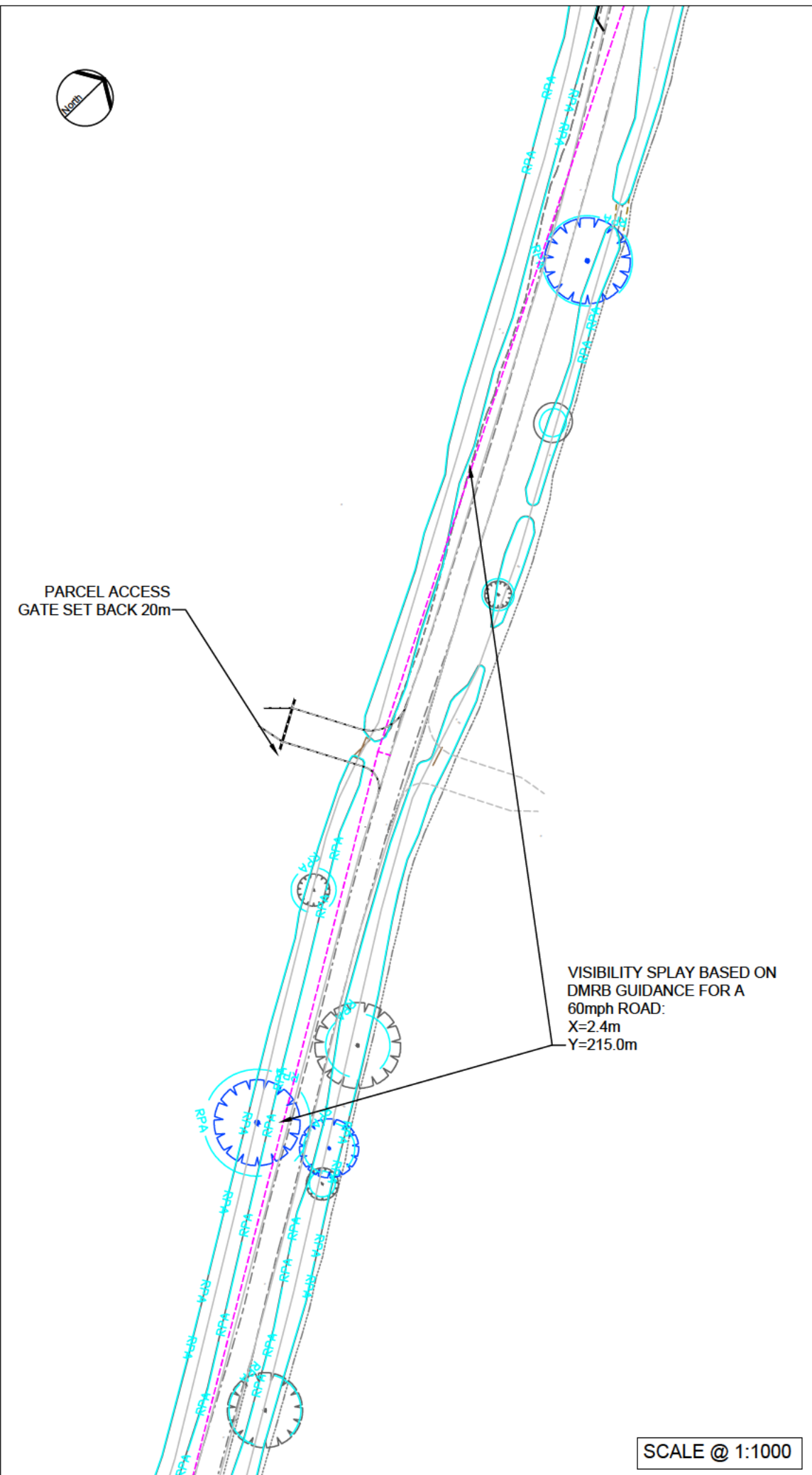

LEGEND

- Order limits
- Areas outside of Order limits
- Access Visibility Splay

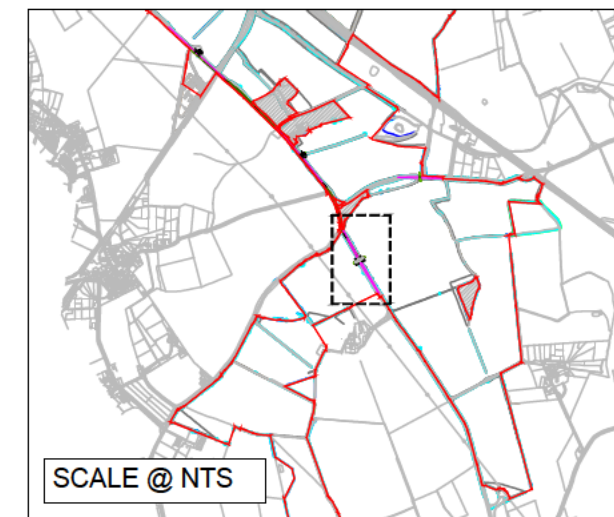

| REV. | DESCRIPTION | APP. DATE |
|------|-------------|-----------|
|------|-------------|-----------|

LD A DESIGN

PROJECT TITLE
**MALLARD PASS SOLAR FARM
 OUTLINE CONSTRUCTION MANAGEMENT PLAN**

DRAWING TITLE
**ACCESS D
 SITE ACCESS JUNCTION - SWEEP
 PATH ANALYSIS**

| | | |
|-----------|----------|------------------|
| ISSUED BY | Oxford | T: 01865 887 050 |
| DATE | 04/03/22 | DRAWN GSF |
| SCALE@A3 | As shown | CHECKED CR |
| STATUS | Sketch | APPROVED MK |

DWG. NO 4990-2001-T-030-D

No dimensions are to be scaled from this drawing.
 All dimensions are to be checked on site.
 Area measurements for indicative purposes only.

© LDA Design Consulting Ltd. Quality Assured to BS EN ISO 9001 : 2015
 Sources Ordnance Survey

C:\USERS\GFLTCHER\PIVTP - CAD\DA_4990\2002_MALLARD PASS SOLAR FARM\CAD\1.0 CURRENT\1.0.1 SHEETS\4990-2001-T-024-033-D - ACCESS ARRANGEMENT DETAILS.DWG

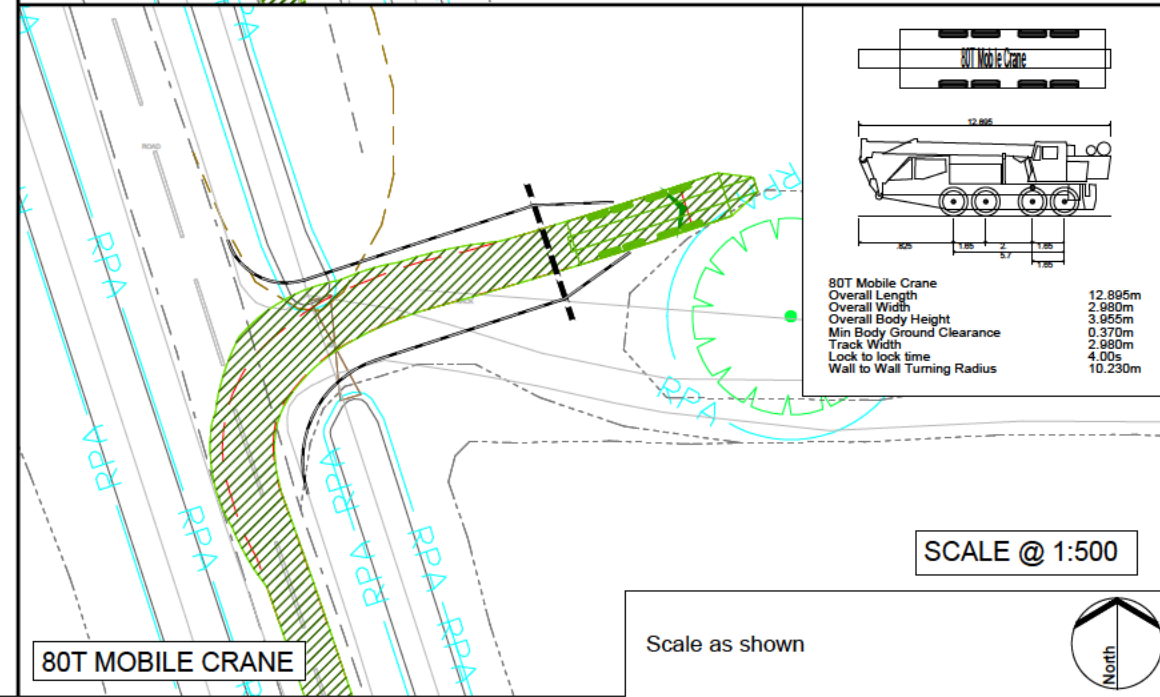
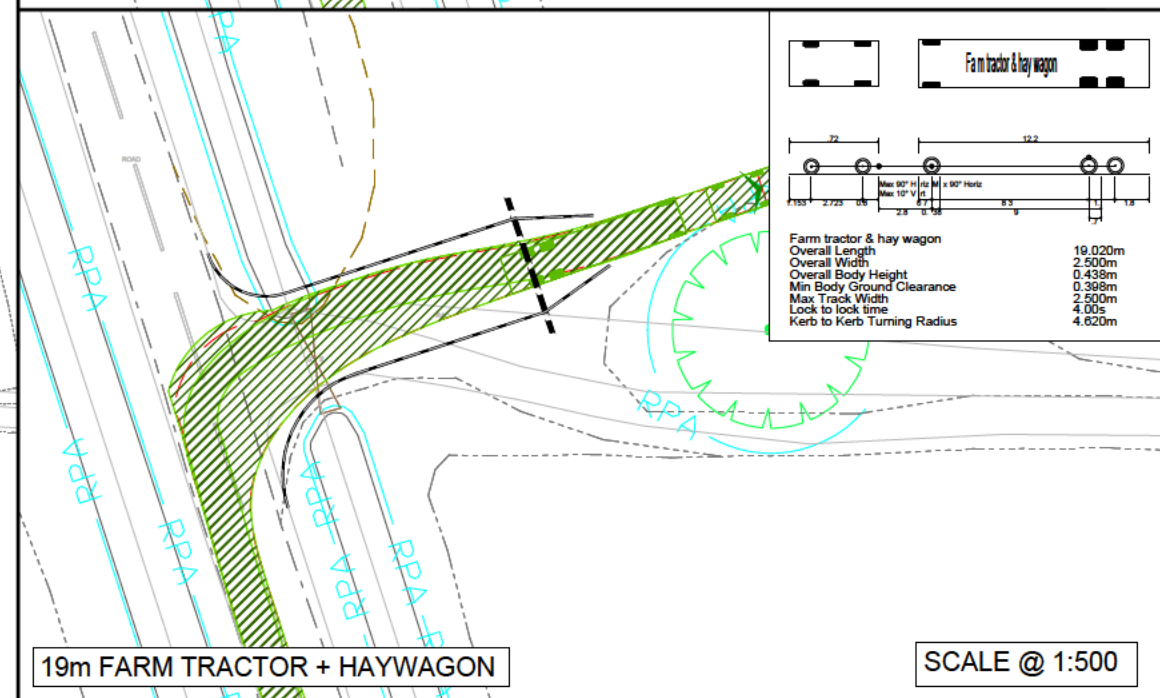
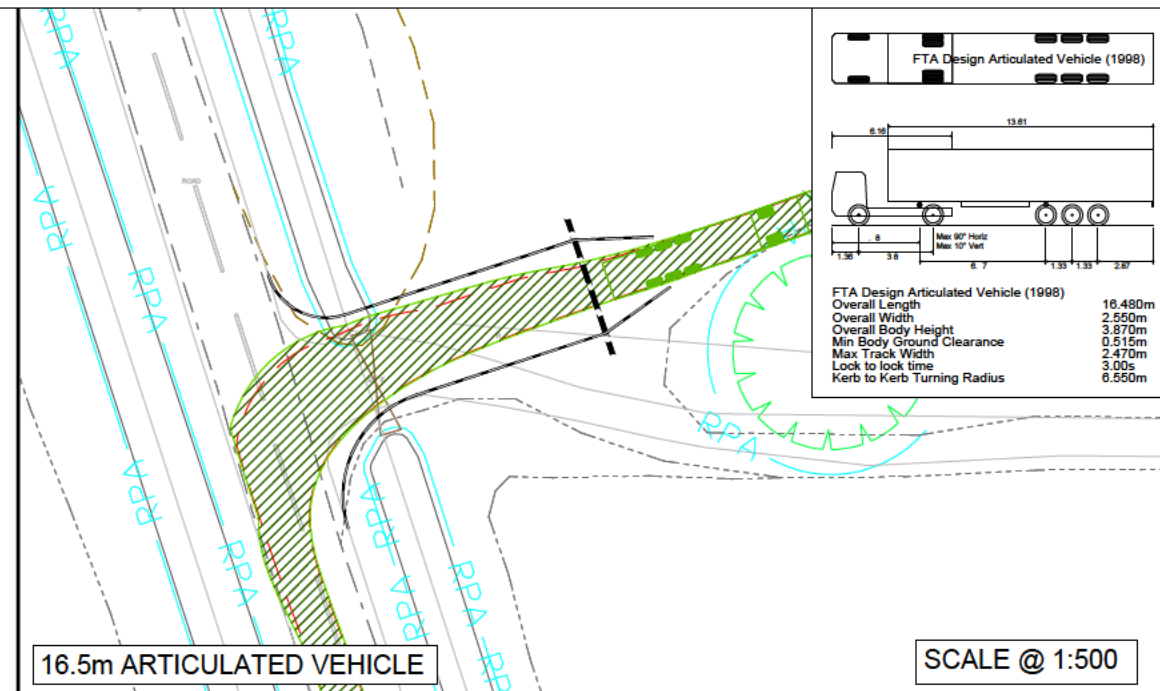
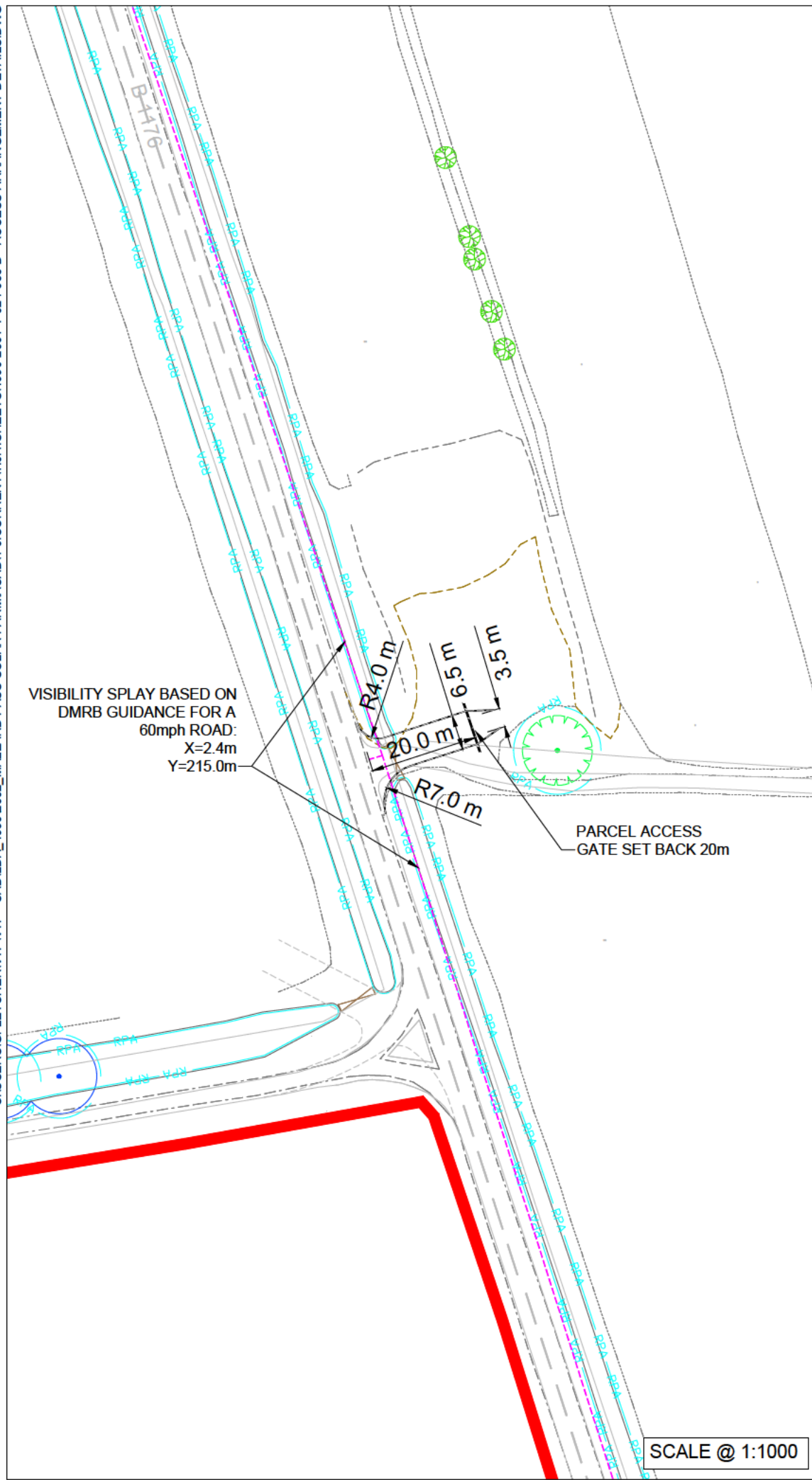

| REV. | DESCRIPTION | APP. DATE |
|------|-------------|-----------|
|------|-------------|-----------|

LD A DESIGN

PROJECT TITLE
MALLARD PASS SOLAR FARM
OUTLINE CONSTRUCTION MANAGEMENT PLAN

DRAWING TITLE
ACCESS F
SITE ACCESS JUNCTION - SWEEP
PATH ANALYSIS

| | | |
|-----------|----------|------------------|
| ISSUED BY | Oxford | T: 01865 887 050 |
| DATE | 04/03/22 | DRAWN GSF |
| SCALE@A3 | As shown | CHECKED CR |
| STATUS | Sketch | APPROVED MK |

DWG. NO 4990-2001-T-025-D

No dimensions are to be scaled from this drawing.
 All dimensions are to be checked on site.
 Area measurements for indicative purposes only.

© LDA Design Consulting Ltd. Quality Assured to BS EN ISO 9001 : 2015
 Sources Ordnance Survey

C:\USERS\GFLETCHER\PIVTP - CAD\LD_4990\2002_MALLARD PASS SOLAR FARM\CAD11.0.1.SHEETS\4990-2001-T-024-033-D - ACCESS ARRANGEMENT DETAILS.DWG

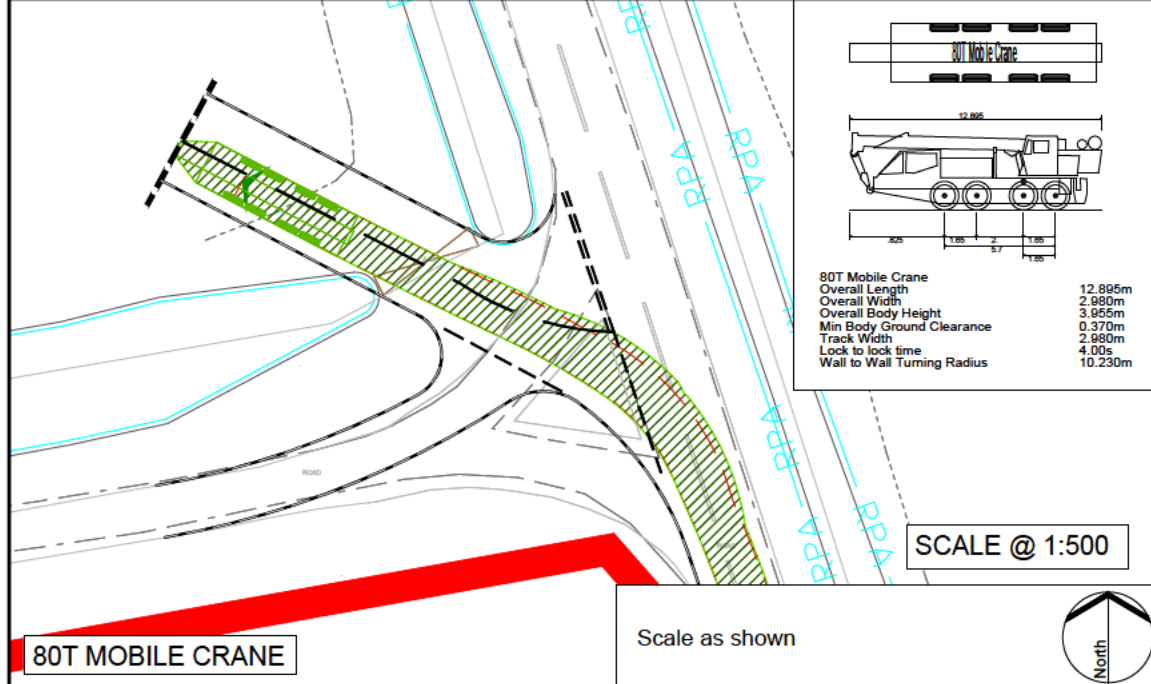
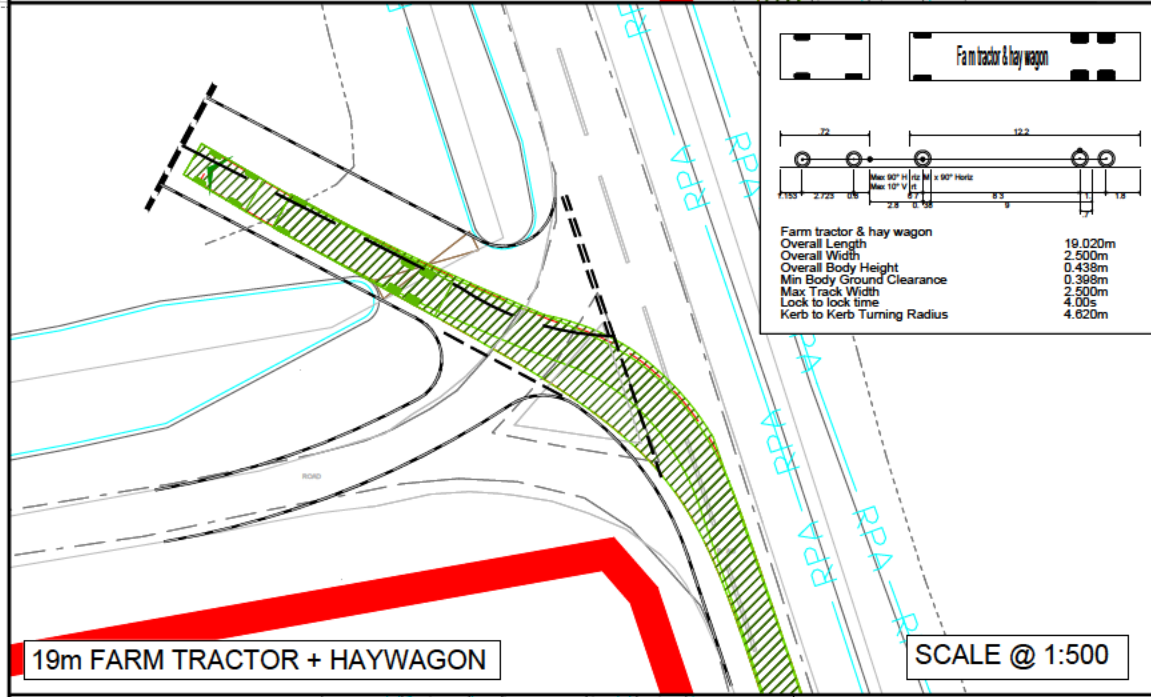
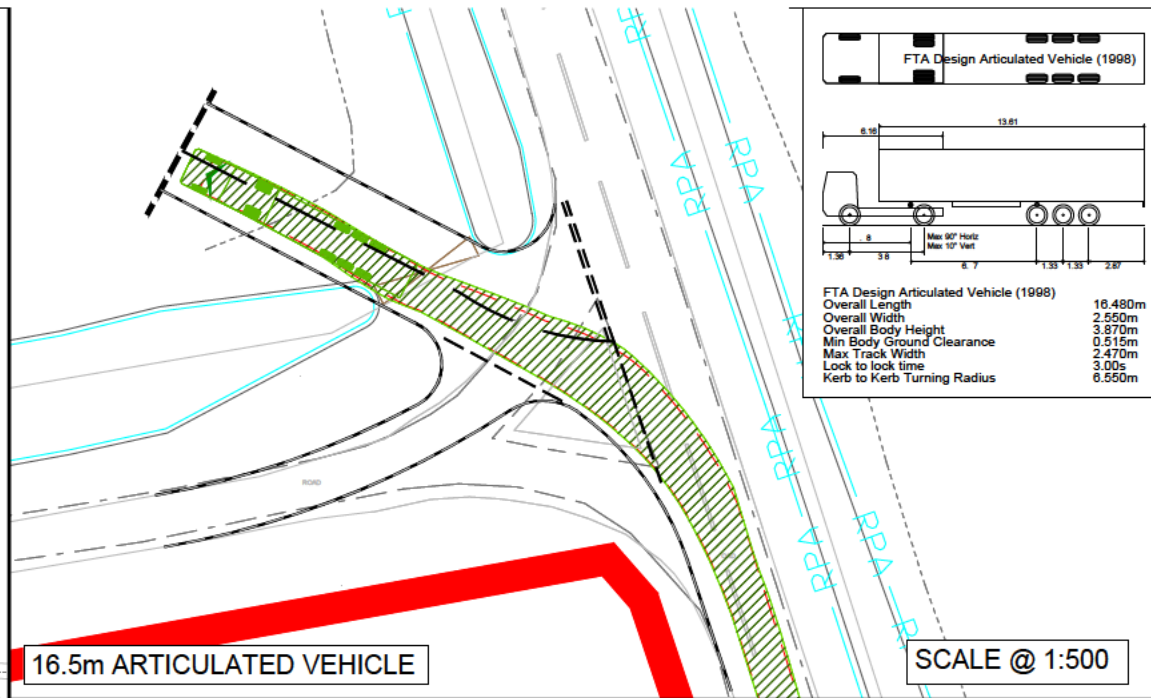
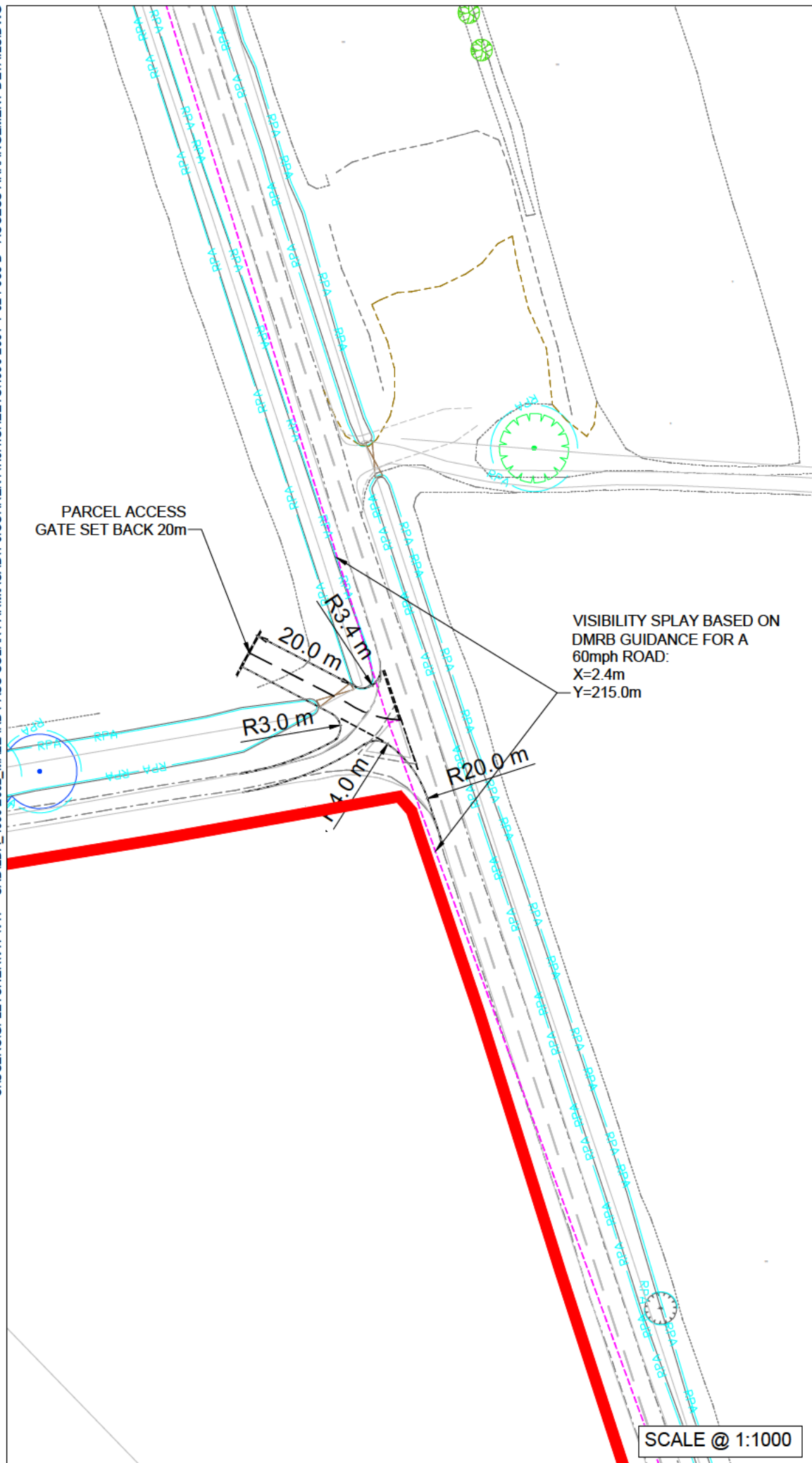

LEGEND

- Order limits
- Areas outside of Order limits
- Access Visibility Splay

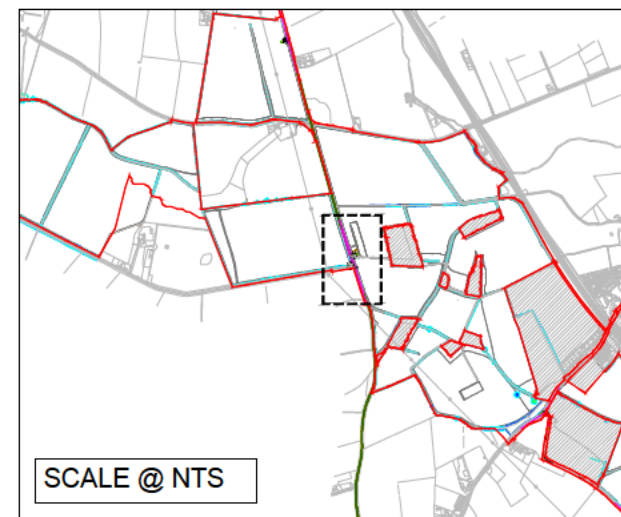

| REV. | DESCRIPTION | APP. DATE |
|------|-------------|-----------|
|------|-------------|-----------|

LD A DESIGN

PROJECT TITLE
MALLARD PASS SOLAR FARM
OUTLINE CONSTRUCTION MANAGEMENT PLAN

DRAWING TITLE
ACCESS G
SITE ACCESS JUNCTION - SWEEP
PATH ANALYSIS

| | | |
|-----------|----------|------------------|
| ISSUED BY | Oxford | T: 01865 887 050 |
| DATE | 04/03/22 | DRAWN GSF |
| SCALE@A3 | As shown | CHECKED CR |
| STATUS | Sketch | APPROVED MK |

DWG. NO 4990-2001-T-026-D

No dimensions are to be scaled from this drawing.
 All dimensions are to be checked on site.
 Area measurements for indicative purposes only.

© LDA Design Consulting Ltd. Quality Assured to BS EN ISO 9001 : 2015
 Sources Ordnance Survey

C:\USERS\GFLETCHER\PIVTP - CAD\DA_4990\2002_MALLARD PASS SOLAR FARM\CAD\11.0.1.SHEETS\4990-2001-T-024-033-D - ACCESS ARRANGEMENT DETAILS.DWG

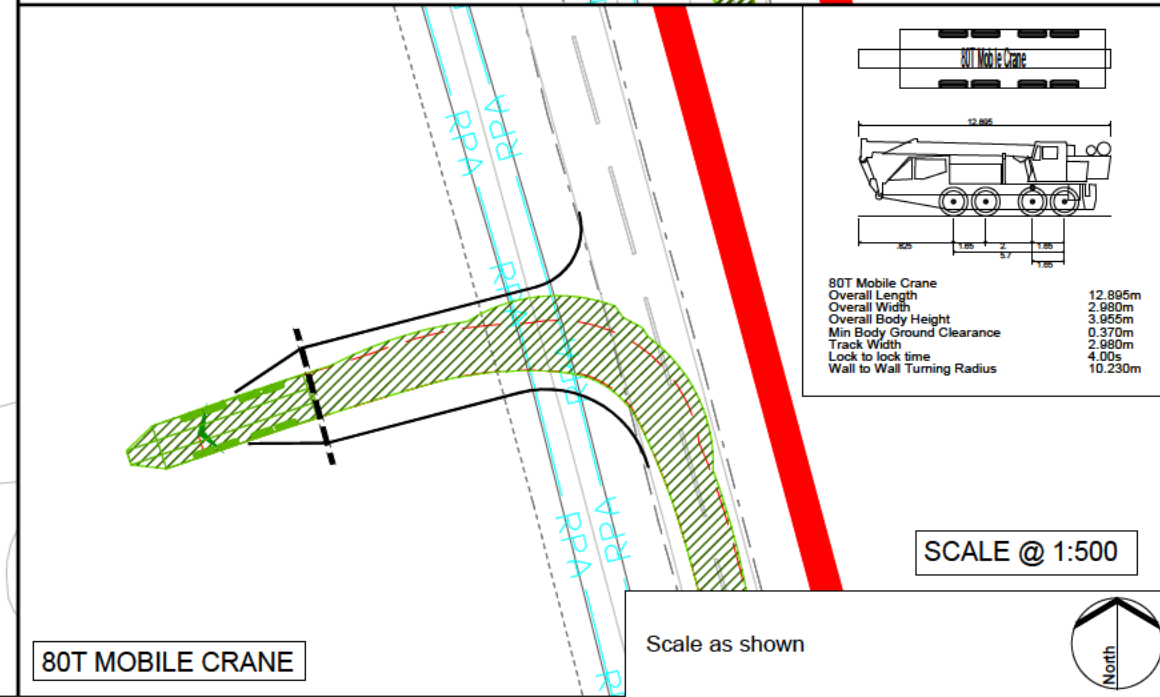
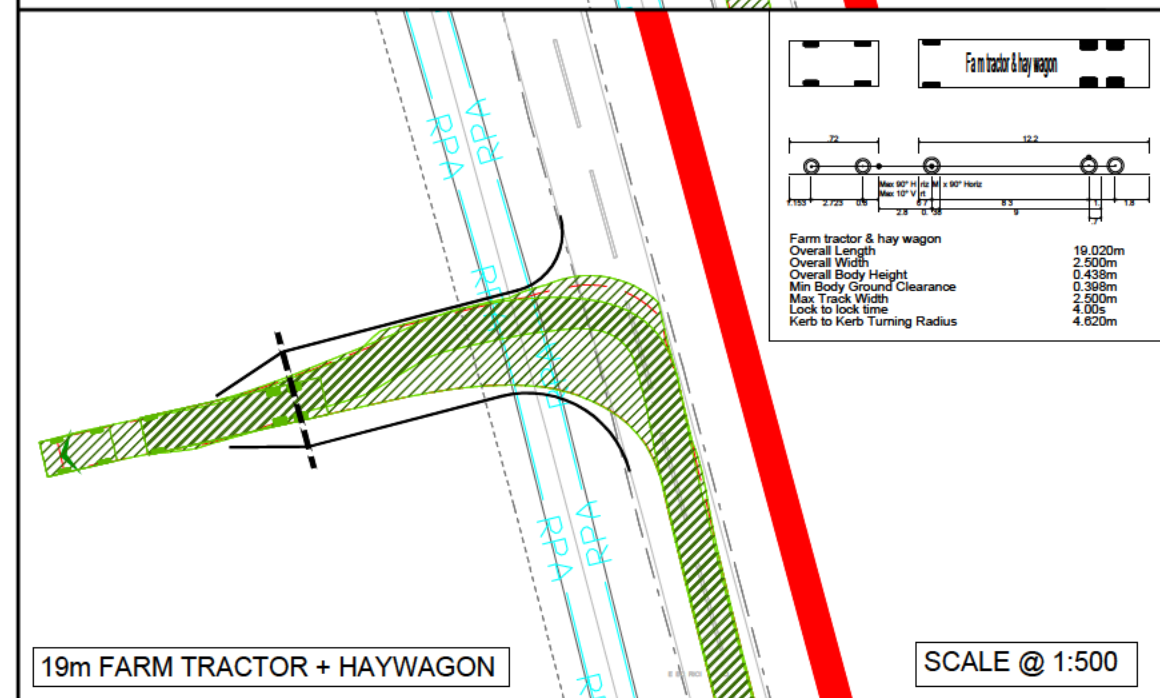
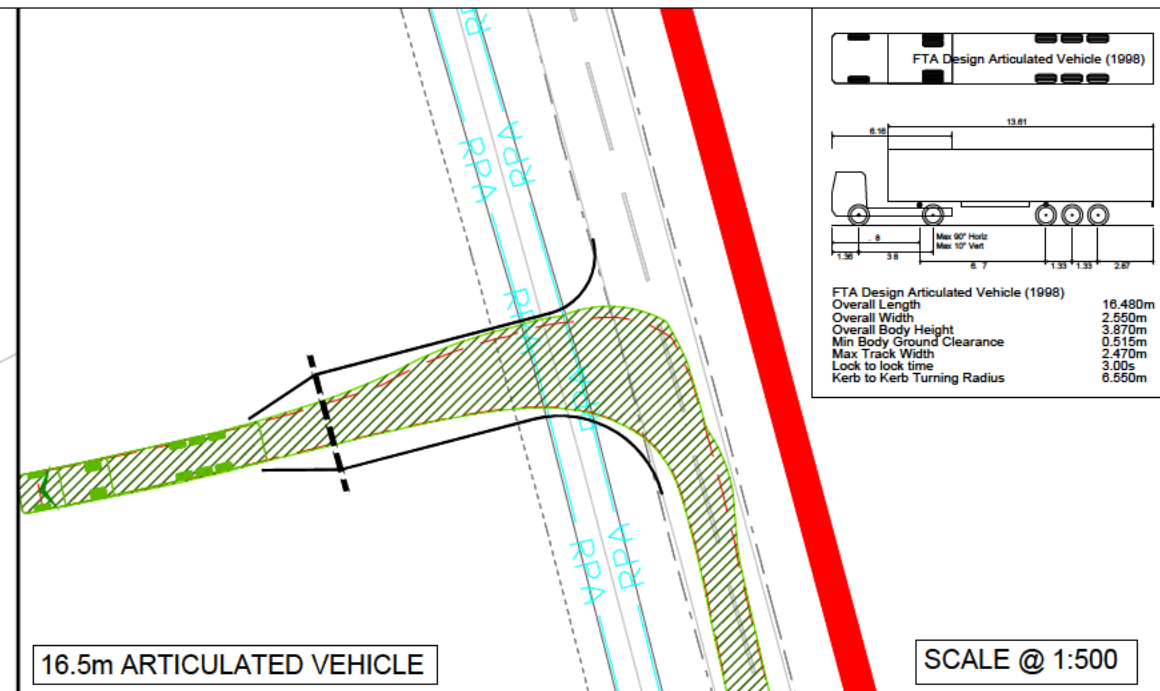
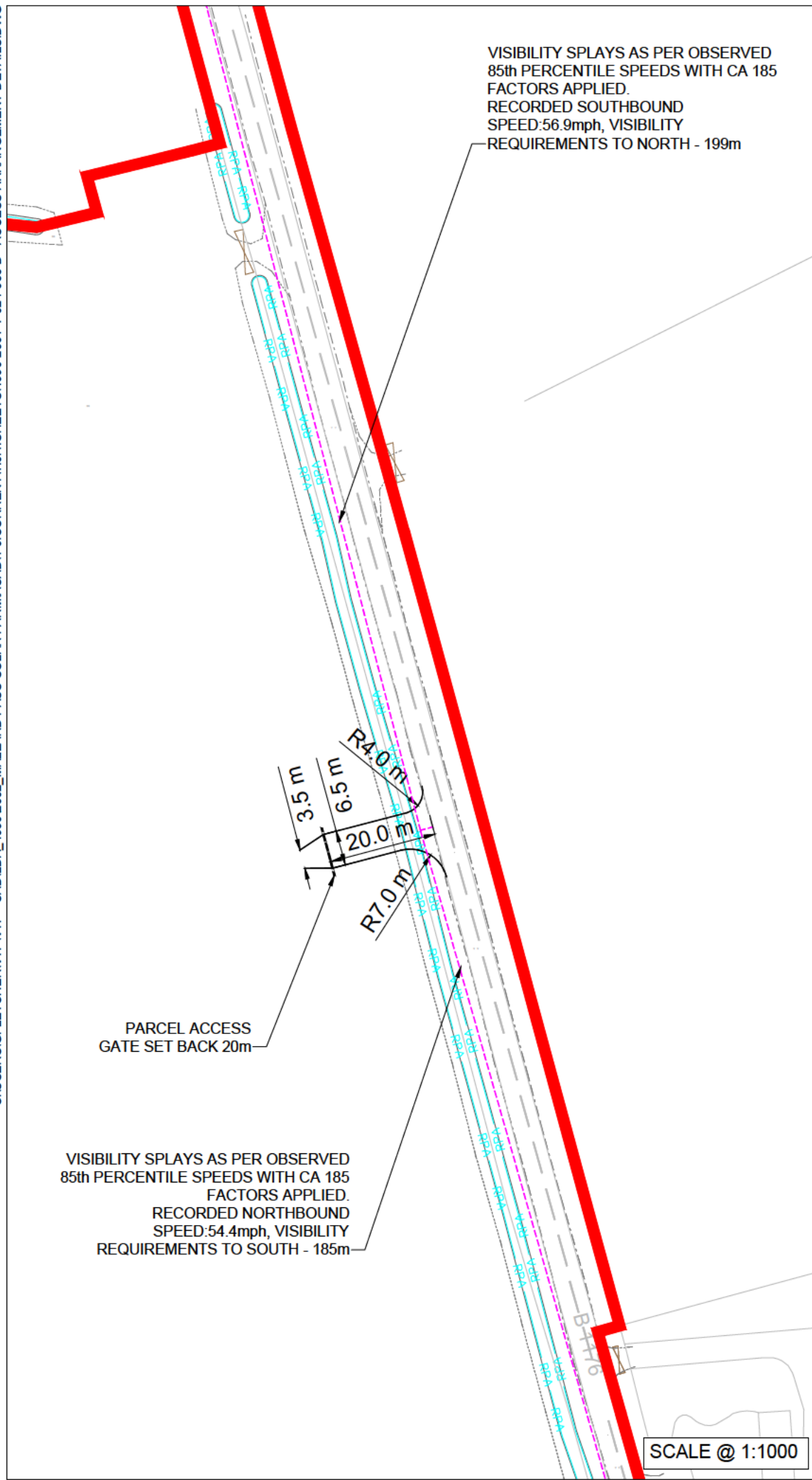

LEGEND

- Order limits
- Areas outside of Order limits
- Access Visibility Splay

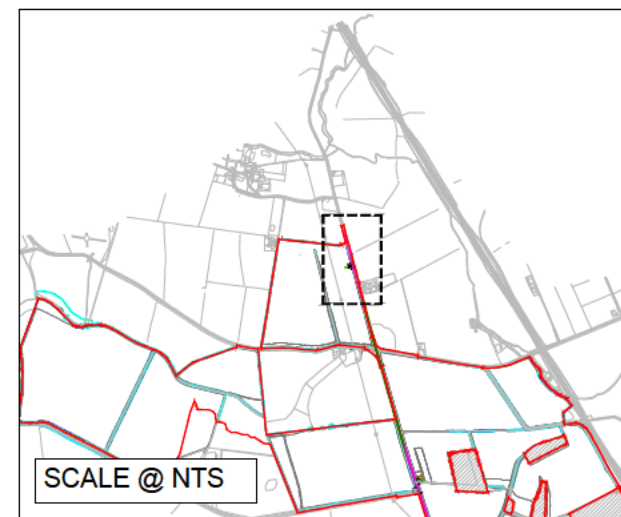

| REV. | DESCRIPTION | APP. DATE |
|------|-------------|-----------|
|------|-------------|-----------|

LD A DESIGN

PROJECT TITLE
**MALLARD PASS SOLAR FARM
 OUTLINE CONSTRUCTION MANAGEMENT PLAN**

DRAWING TITLE
**ACCESS H
 SITE ACCESS JUNCTION - SWEEP
 PATH ANALYSIS**

| | | |
|-----------|----------|------------------|
| ISSUED BY | Oxford | T: 01865 887 050 |
| DATE | 04/03/22 | DRAWN GSF |
| SCALE@A3 | As shown | CHECKED CR |
| STATUS | Sketch | APPROVED MK |

DWG. NO 4990-2001-T-024-D

No dimensions are to be scaled from this drawing.
 All dimensions are to be checked on site.
 Area measurements for indicative purposes only.

© LDA Design Consulting Ltd. Quality Assured to BS EN ISO 9001 : 2015
 Sources Ordnance Survey

C:\USERS\GFLETCHER\PIVTP - CAD\DA_4990\2002_MALLARD PASS SOLAR FARM\CAD\1.0.1 SHEETS\4990-2001-T-024-033-D - ACCESS ARRANGEMENT DETAILS.DWG

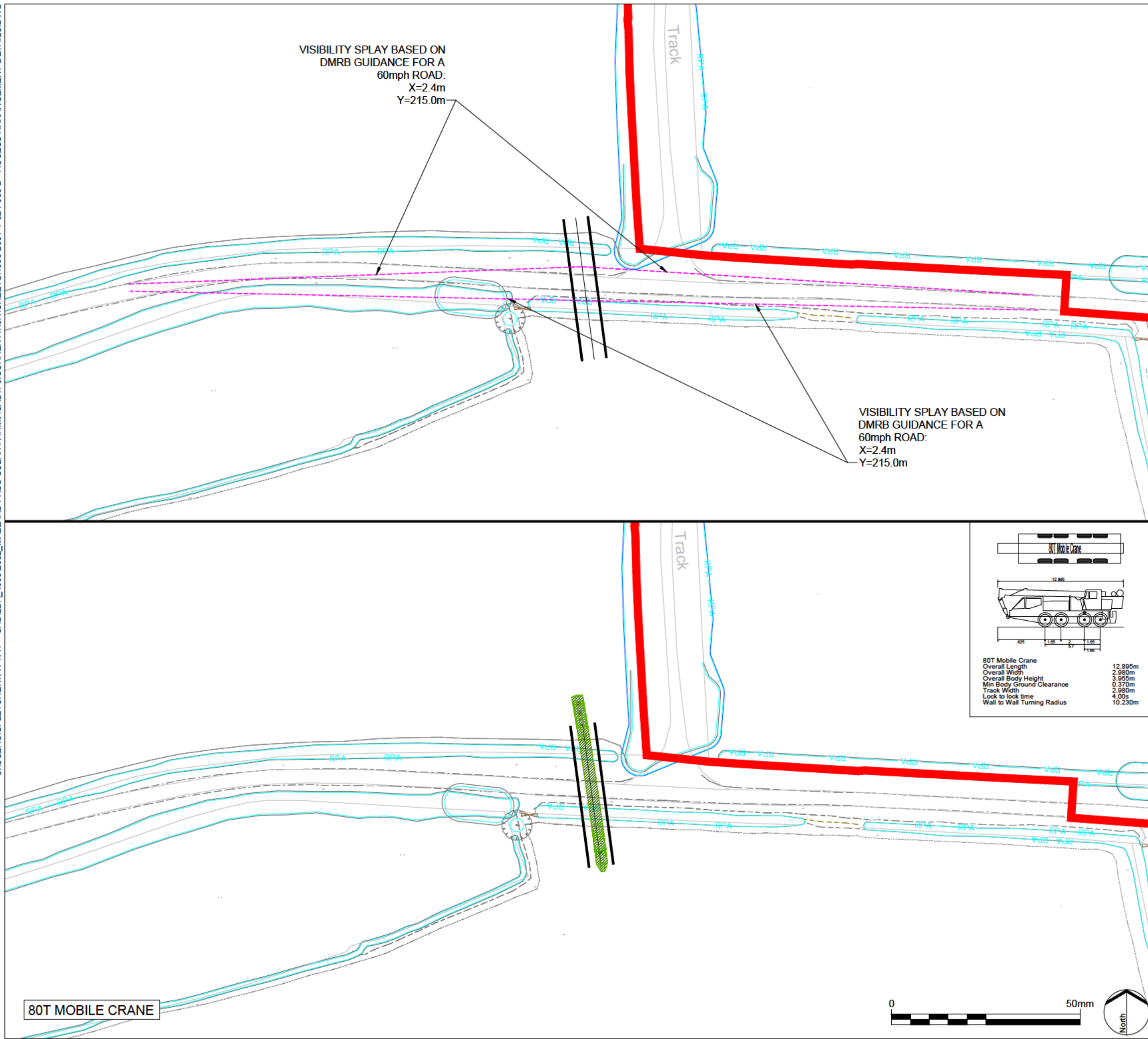

LEGEND

-  Order limits
-  Areas outside of Order limits
-  Access Visibility Splay

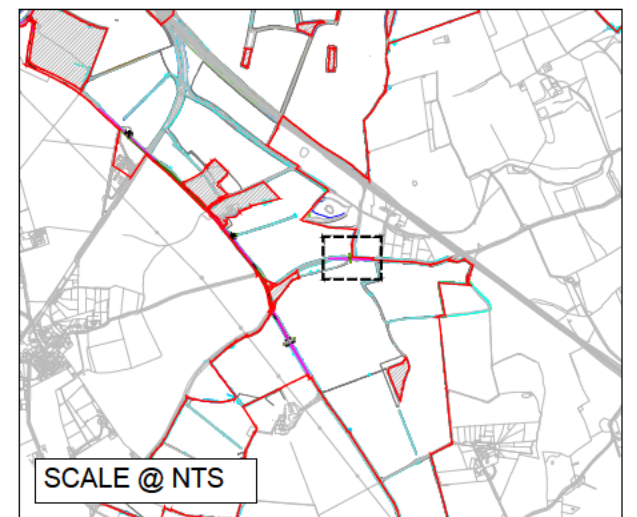

| 80T Mobile Crane | |
|-----------------------------|---------|
| Overall Length | 12.895m |
| Overall Width | 2.980m |
| Overall Body Height | 3.955m |
| Min Body Ground Clearance | 0.370m |
| Track Width | 2.980m |
| Lock to lock time | 4.00s |
| Wall to Wall Turning Radius | 10.230m |

| REV. | DESCRIPTION | APP. DATE |
|------|-------------|-----------|
| | | |

LD A DESIGN

PROJECT TITLE
**MALLARD PASS SOLAR FARM
 OUTLINE CONSTRUCTION MANAGEMENT PLAN**

DRAWING TITLE
**ACCESS I & J - CROSSOVER
 SITE ACCESS JUNCTION - SWEEP
 PATH ANALYSIS**

| | | |
|-----------|----------|------------------|
| ISSUED BY | Oxford | T: 01865 887 050 |
| DATE | 04/03/22 | DRAWN GSF |
| SCALE@A3 | 1:1 | CHECKED CR |
| STATUS | Sketch | APPROVED MK |

DWG. NO 4990-2001-T-033-D

No dimensions are to be scaled from this drawing.
 All dimensions are to be checked on site.
 Area measurements for indicative purposes only.

© LDA Design Consulting Ltd. Quality Assured to BS EN ISO 9001 : 2015

Sources Ordnance Survey

80T MOBILE CRANE



C:\USERS\GFLETCHER\PIVTP - CAD\DA_49902002_MALLARD PASS SOLAR FARM\CAD1.0.CURRENT\1.0.1.SHEETS\4990-2001-T-045-046-D - HGV PASSING POINTS BASED ON TOPO.

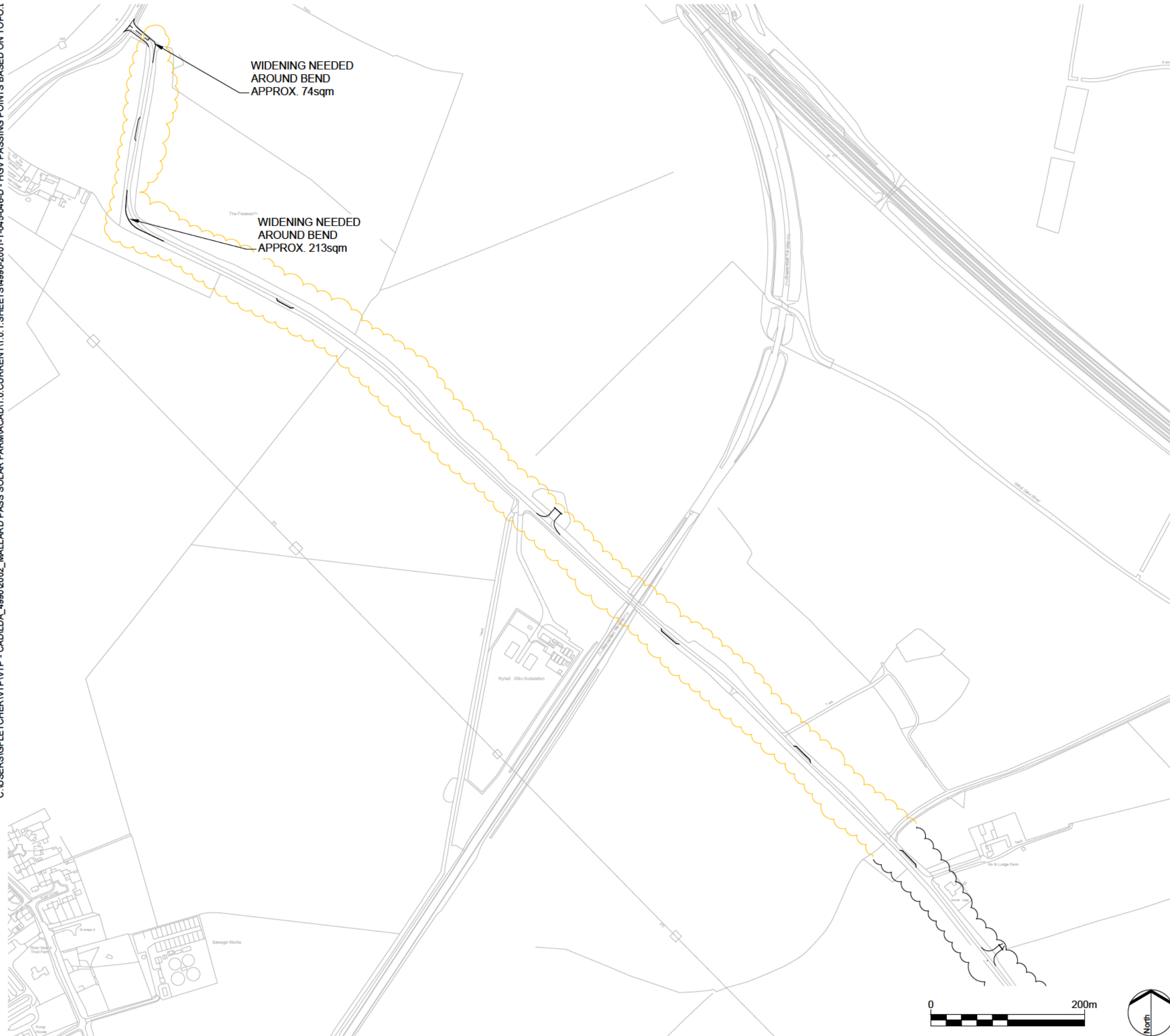



PASSING BAY LOCATIONS:

PASSING BAY LOCATIONS WITHIN LOCAL WILDLIFE SITE (LWS)
- 5 (230 Sqm)

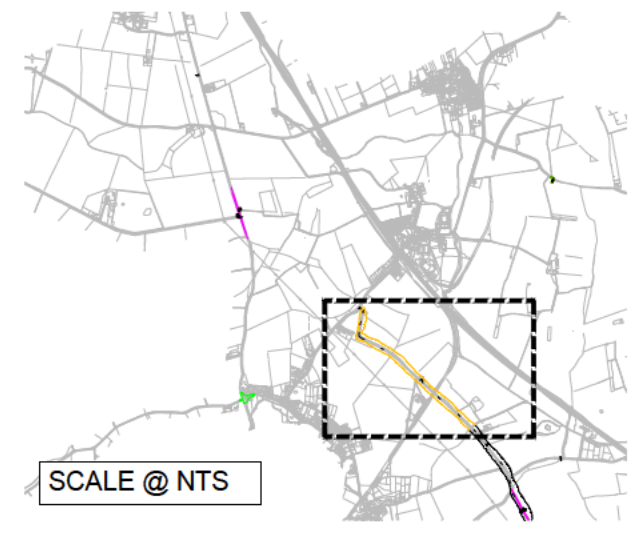
TOTAL PASSING BAY LOCATIONS INCLUDING LOCAL WILDLIFE SITE (LWS)
- 6 (276 Sqm)



KEY:

-  AREAS WHERE PASSING PLACES REQUIRED
-  AREAS WHERE PASSING PLACES REQUIRED - LOCAL WILDLIFE SITE (LWS)

| REV. | DESCRIPTION | APP. DATE |
|------|-------------|-----------|
|------|-------------|-----------|

LDĀDESIGN

PROJECT TITLE
MALLARD PASS SOLAR FARM

DRAWING TITLE
PASSING POINT LOCATIONS

| | | |
|-----------|----------|------------------|
| ISSUED BY | Oxford | T: 01865 887 050 |
| DATE | 13/07/22 | DRAWN GSF |
| SCALE@A3 | 1:5,000 | CHECKED CR |
| STATUS | Sketch | APPROVED MK |

DWG. NO 4990-2001-T-045-D

No dimensions are to be scaled from this drawing.
All dimensions are to be checked on site.
Area measurements for indicative purposes only.

© LDA Design Consulting Ltd. Quality Assured to BS EN ISO 9001 : 2015

Sources Ordnance Survey



C:\USERS\G\FLETCHER\VP\TP - CAD\DA_4990\2002_MALLARD PASS SOLAR FARM\CAD\11 0 CURRENT\11 0 1 SHEETS\4990-2001-T-046-046-D - HGV PASSING POINTS BASED ON TOPOI

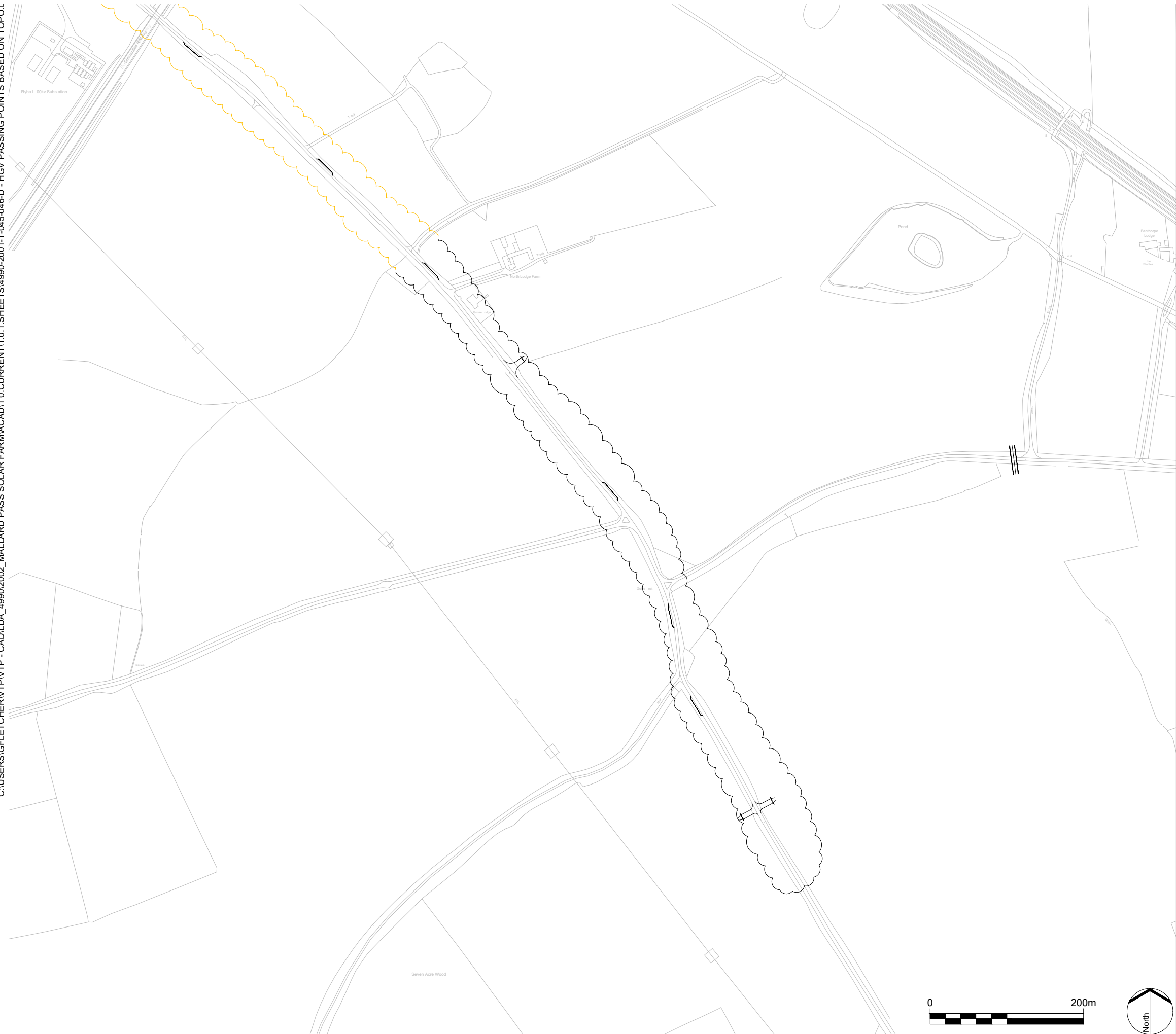

PASSING BAY LOCATIONS:

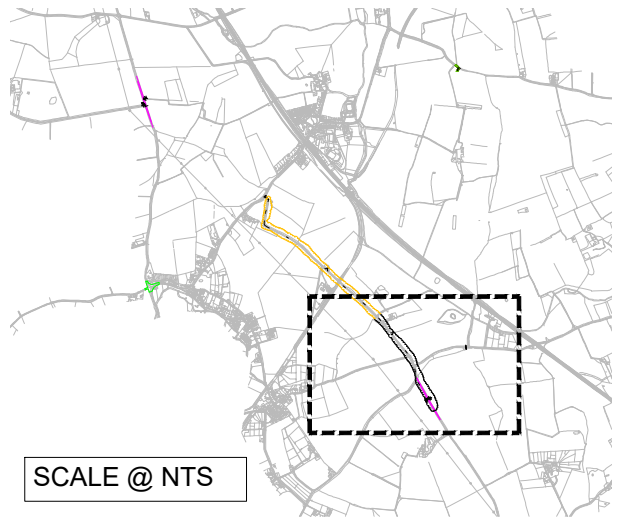

PASSING BAY LOCATIONS WITHIN LOCAL WILDLIFE SITE (LWS)
- 2 (92 Sqm)

TOTAL PASSING BAY LOCATIONS INCLUDING LOCAL WILDLIFE SITE (LWS)
- 6 (276 Sqm)

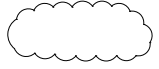

SCALE @ NTS

KEY:

-  AREAS WHERE PASSING PLACES REQUIRED
-  AREAS WHERE PASSING PLACES REQUIRED - LOCAL WILDLIFE SITE (LWS)

| REV. | DESCRIPTION | APP. DATE |
|------|-------------|-----------|
|------|-------------|-----------|

LDĀ DESIGN

PROJECT TITLE
MALLARD PASS SOLAR FARM

DRAWING TITLE
PASSING POINT LOCATIONS

| | | |
|-----------|----------|------------------|
| ISSUED BY | Oxford | T: 01865 887 050 |
| DATE | 13/07/22 | DRAWN GSF |
| SCALE@A3 | 1:5,000 | CHECKED CR |
| STATUS | Sketch | APPROVED MK |

DWG. NO 4990-2001-T-046-D

No dimensions are to be scaled from this drawing.
All dimensions are to be checked on site.
Area measurements for indicative purposes only.

© LDA Design Consulting Ltd. Quality Assured to BS EN ISO 9001 : 2015

Sources Ordnance Survey

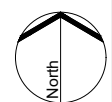

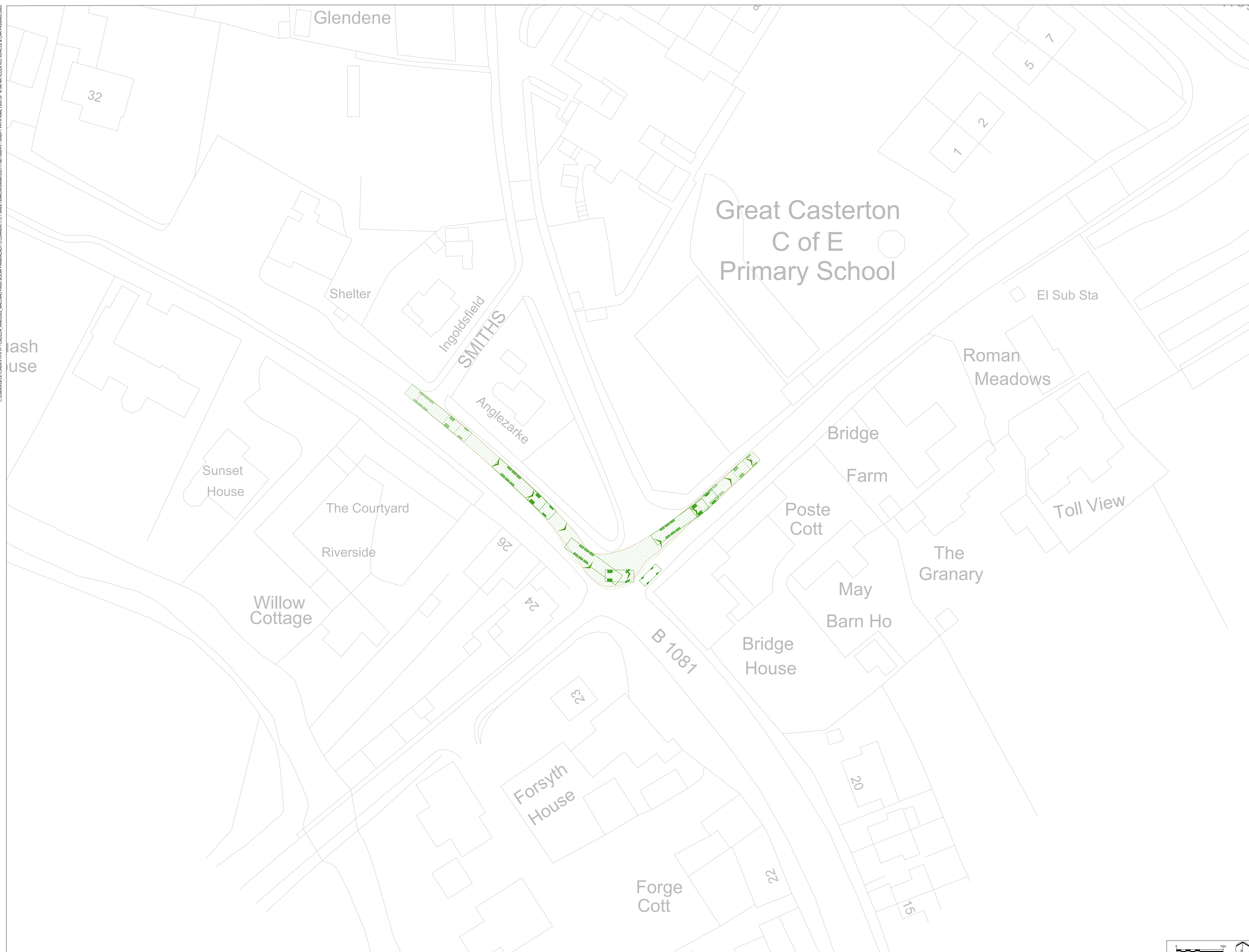

LEGEND

FTA Design Articulated Vehicle (1998)

- Overall Length: 16.50m
- Overall Width: 2.55m
- Overall Body Height: 2.87m
- Min Body Ground Clearance: 1.21m
- Max Track Width: 1.71m
- Lock to lock time: 4.00s
- Kerb to Kerb Turning Radius: 6.20m

Large Car

- Overall Length: 4.98m
- Overall Width: 1.73m
- Overall Body Height: 1.52m
- Min Body Ground Clearance: 0.28m
- Track Width: 1.70m
- Lock to lock time: 4.00s
- Kerb to Kerb Turning Radius: 6.20m

Key Plan

PO: Examination
REV: DESCRIPTION

APP: 28/06/23
APP: DATE

PROJECT TITLE
MALLARD PASS SOLAR FARM

DRAWING TITLE
Swept path analysis of 16.5m articulated vehicle and large car passing

Infrastructure Planning (Examination Procedure) Rules 2010

INS REFERENCE NUMBER
EN010127

ISSUED BY: Oxford T: 01865 887 050
DATE: 28 June 2023 DRAWN: GSP
SCALE: A3 1:250 CHECKED: OR
STATUS: Final APPROVED: RP

DWG. NO 4990-2001-T-067 REV: P0

No dimensions are to be scaled from this drawing.
All dimensions are to be checked on site.
Area measurements for indicative purposes only.

© C.I.D.A. Design Consulting Ltd. Quality Assured to BS EN ISO 9001: 2015
Source: Ordnance Survey

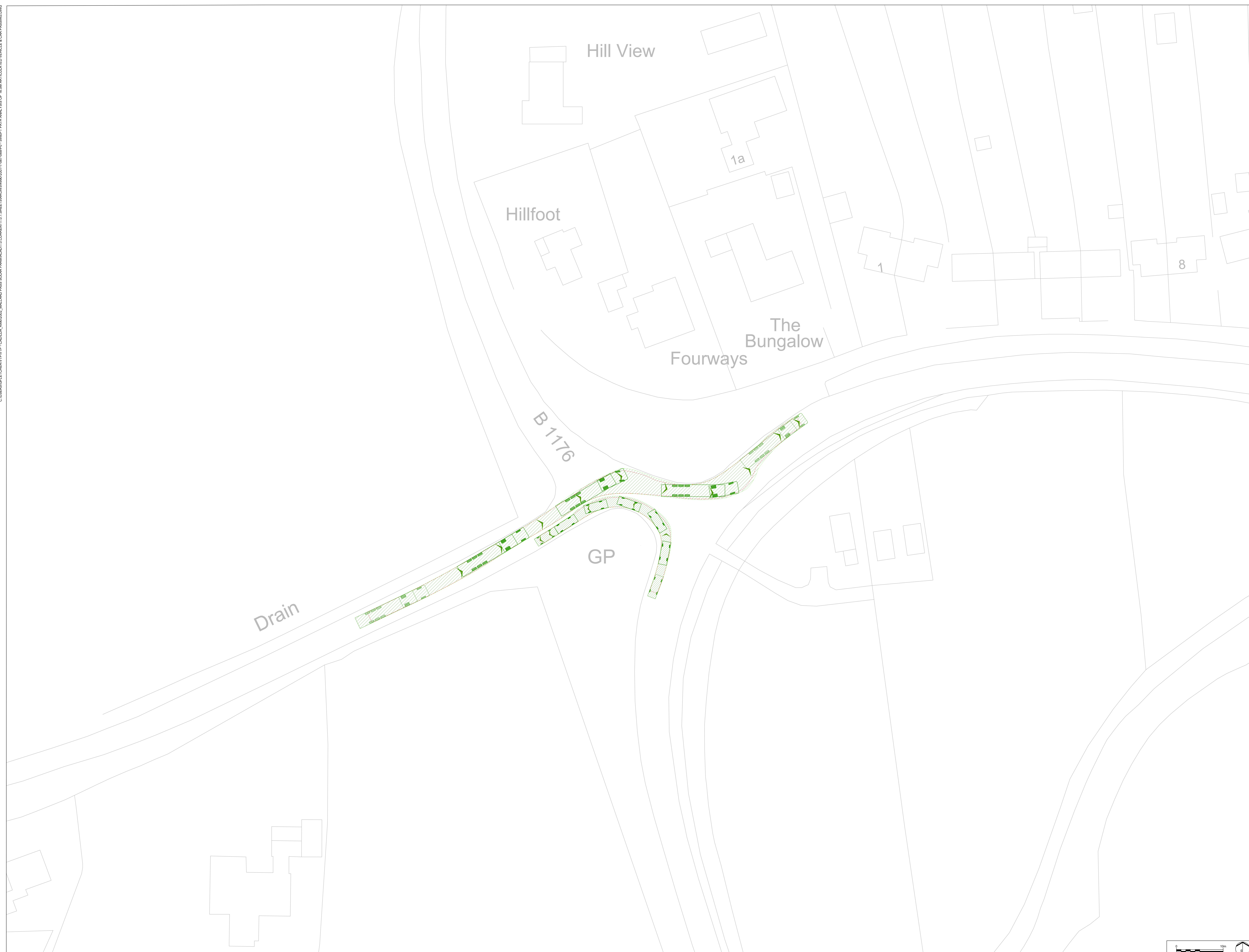
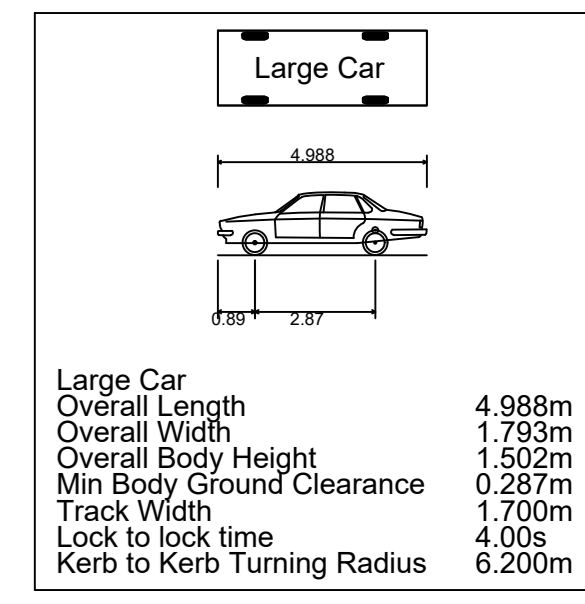
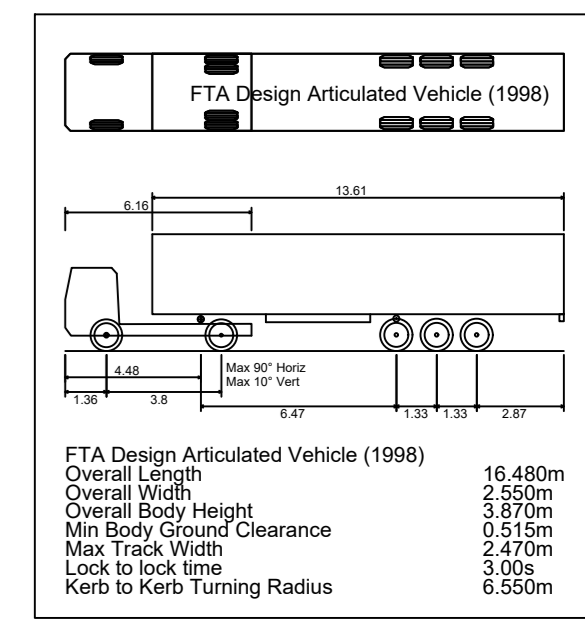

Key Plan

| | | | |
|------|-------------|------|----------|
| PO | Examination | RP | 28/06/23 |
| REV. | DESCRIPTION | APP. | DATE |

PROJECT TITLE
MALLARD PASS SOLAR FARM

DRAWING TITLE
Swept path analysis of 16.5m articulated vehicle and large car passing

Infrastructure Planning (Examination Procedure)
Rules 2010

ONS REFERENCE NUMBER
EN010127

| | | | |
|-----------|--------------|----------|---------------|
| ISSUED BY | Oxford | T: | 01865 887 050 |
| DATE | 28 June 2023 | DRAWN | GSP |
| SCALE/AD | 1:250 | CHECKED | OR |
| STATUS | Final | APPROVED | RP |

DWG. NO 4990-2001-T-068 REV : PO

No dimensions are to be scaled from this drawing.
All dimensions are to be checked on site.
Area measurements for indicative purposes only.

© GDA Design Consulting Ltd. Quality Assured to BS EN ISO 9001 : 2015
Source: Ordnance Survey

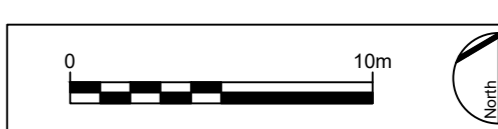

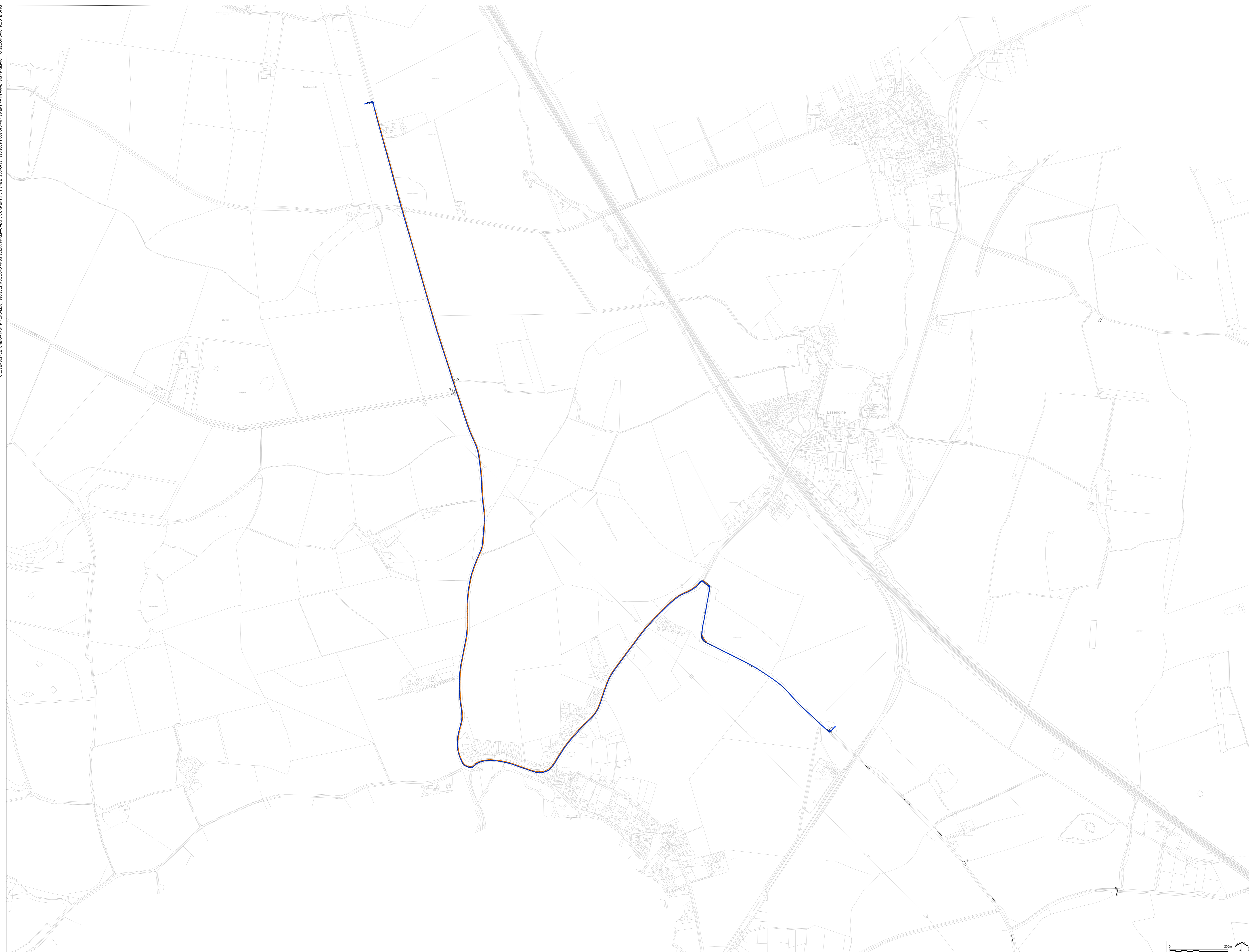
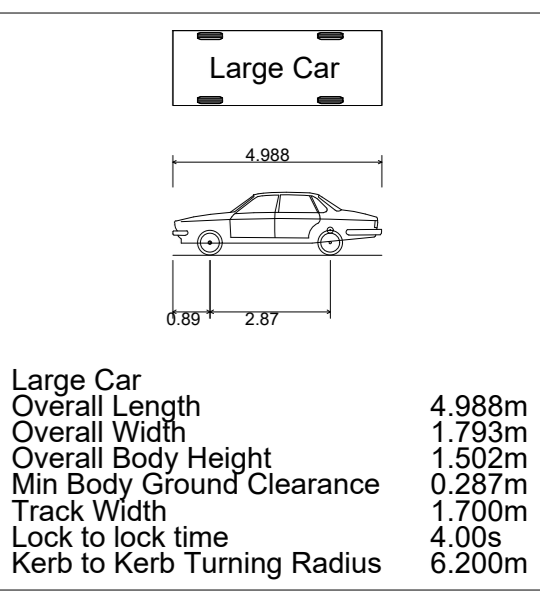
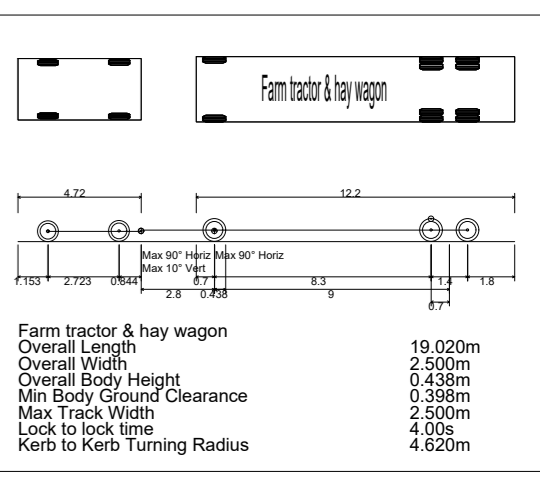

Key Plan

| | |
|------------------|--------------|
| PO: Examination | RP: 28/06/23 |
| REV: DESCRIPTION | APP: DATE |

PROJECT TITLE
MALLARD PASS SOLAR FARM

DRAWING TITLE
Swept path analysis of tractor + trailer & car passing Primary to Secondary - Route 1

Infrastructure Planning (Examination Procedure) Rules 2010

ISSUED BY: Oxford T: 01865 887 050
 DATE: 28 June 2023 DRAWN: GSF
 SCALE: 1:4,000 CHECKED: DR
 STATUS: Final APPROVED: RP

DWG. NO 4990-2001-T-069 REV: P0

No dimensions are to be scaled from this drawing.
 All dimensions are to be checked on site.
 Area measurements for indicative purposes only.

© GDA Design Consulting Ltd. Quality Assured to BS EN ISO 9001: 2015
 Source: Ordnance Survey

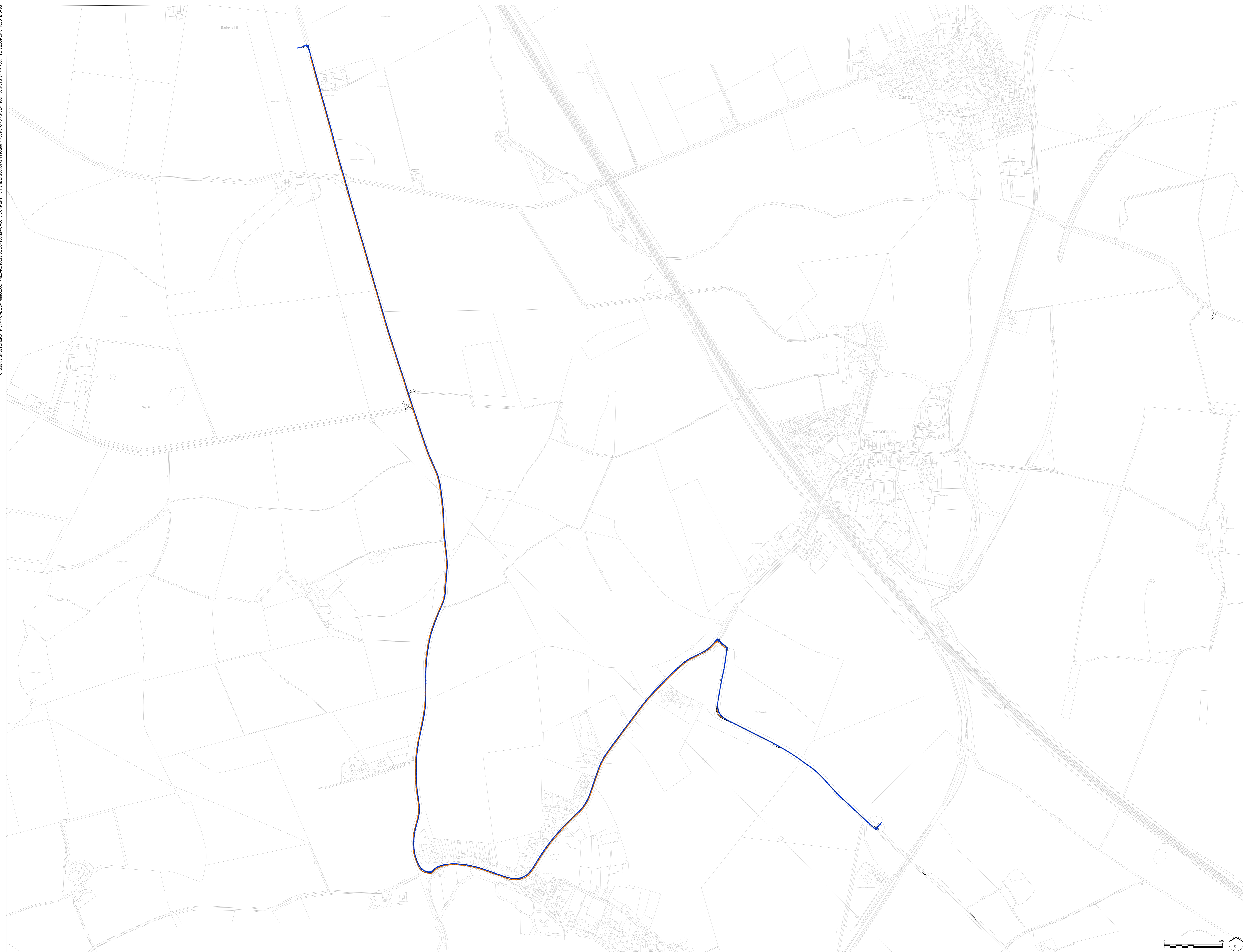
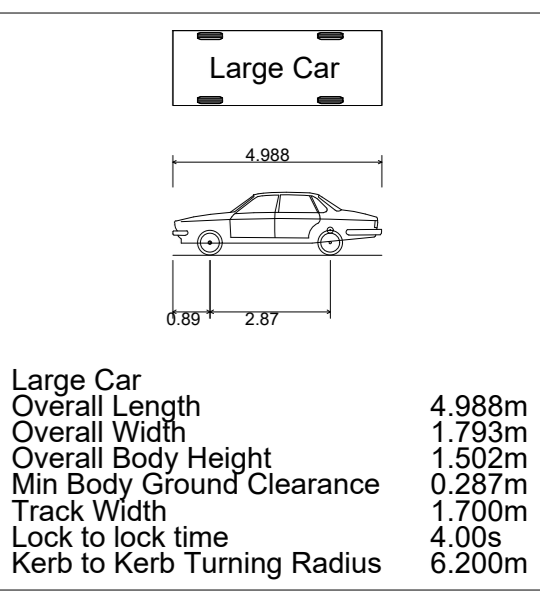
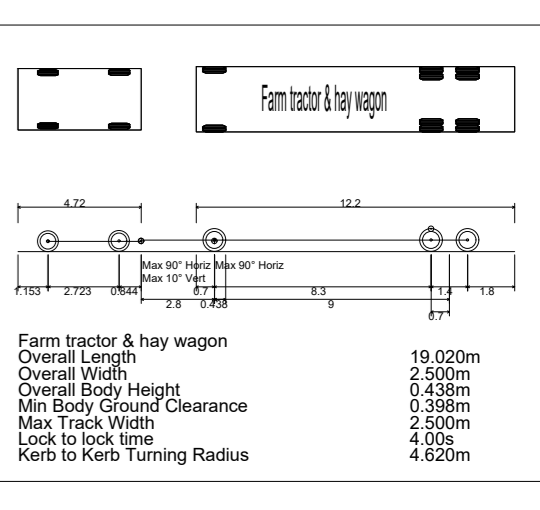

Key Plan

PO: Examination
 REV: DESCRIPTION

RP: 28/06/23
 APP. DATE

PROJECT TITLE
MALLARD PASS SOLAR FARM

DRAWING TITLE
Swept path analysis of tractor + trailer & car passing Primary to Secondary - Route 1

Infrastructure Planning (Examination Procedure) Rules 2010

ISSUE REFERENCE NUMBER
EN010127

| | | |
|-----------|--------------|------------------|
| ISSUED BY | Oxford | T: 01865 887 050 |
| DATE | 28 June 2023 | DRAWN: GSP |
| SCALE/RAD | 1:4,000 | CHECKED: DR |
| STATUS | Final | APPROVED: RP |

DWG. NO 4990-2001-T-070 **REV : P0**

No dimensions are to be scaled from this drawing.
 All dimensions are to be checked on site.
 Area measurements for indicative purposes only.

© GDA Design Consulting Ltd. Quality Assured to BS EN ISO 9001: 2015
 Sources: Ordnance Survey

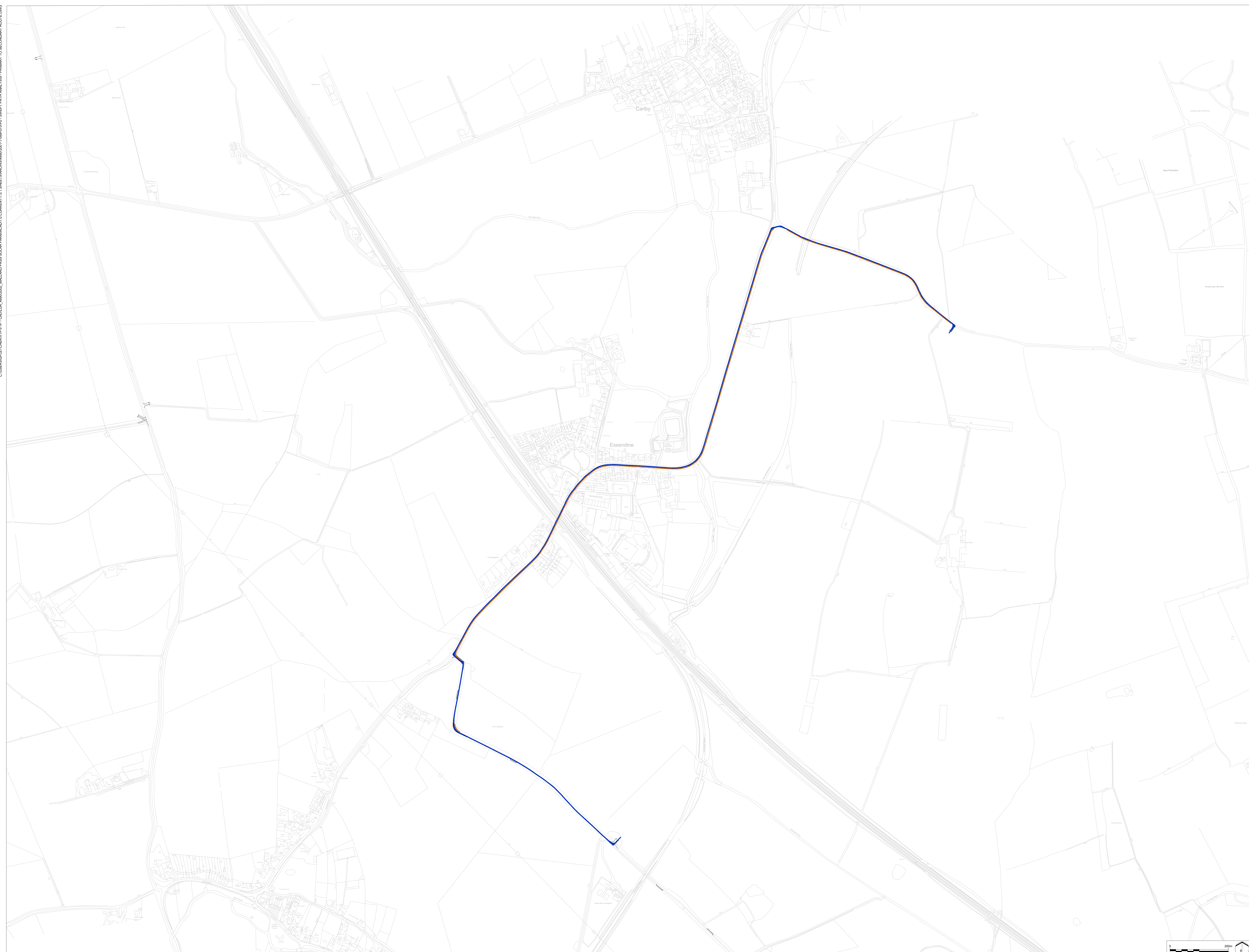
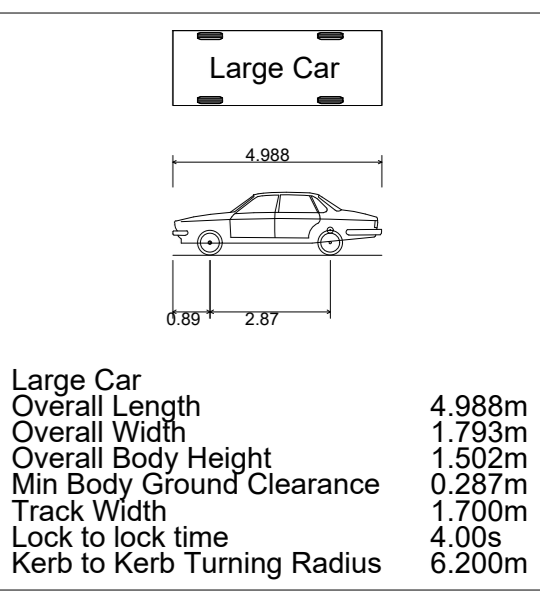
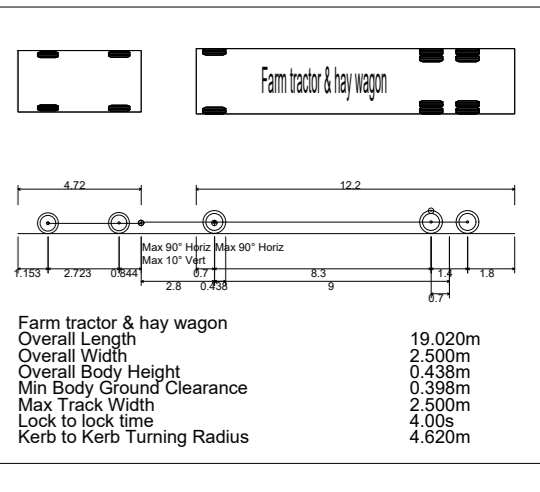

Key Plan

| | | | |
|-----|-------------|-----|----------|
| PO | Examination | RP | 28/06/23 |
| REV | DESCRIPTION | APP | DATE |

PROJECT TITLE
MALLARD PASS SOLAR FARM

DRAWING TITLE
Swept path analysis of tractor + trailer & car passing Primary to Secondary - Route 2

Infrastructure Planning (Examination Procedure) Rules 2010

PNR REFERENCE NUMBER
EN010127

| | | | |
|-----------|--------------|------------------|-----|
| ISSUED BY | Oxford | T: 01865 887 050 | |
| DATE | 28 June 2023 | DRAWN | GSP |
| SCALE/D | 1:4,000 | CHECKED | OR |
| STATUS | Final | APPROVED | RP |

DWG. NO 4990-2001-T-071 **REV : P0**

No dimensions are to be scaled from this drawing.
All dimensions are to be checked on site.
Area measurements for indicative purposes only.

© GDA Design Consulting Ltd. Quality Assured to BS EN ISO 9001: 2015
Source: Ordnance Survey

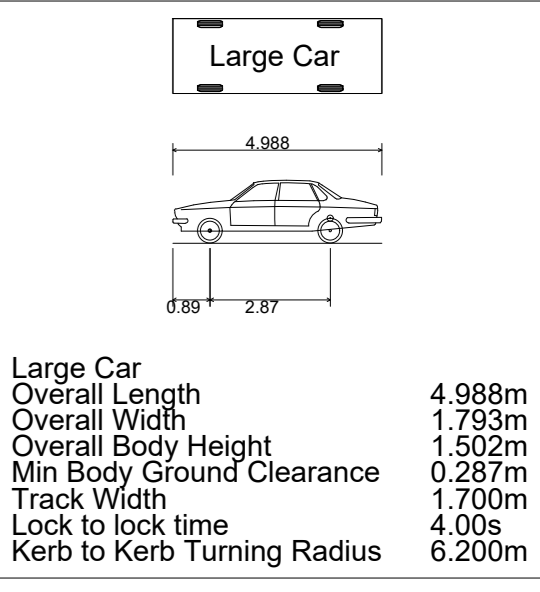
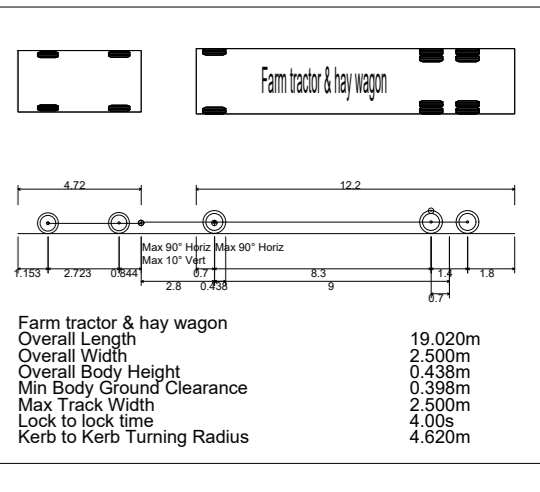

Key Plan

| | | | |
|-----|-------------|-----|----------|
| PO | Examination | RP | 28/06/23 |
| REV | DESCRIPTION | APP | DATE |

PROJECT TITLE
MALLARD PASS SOLAR FARM

DRAWING TITLE
Swept path analysis of tractor + trailer & car passing
Primary to Secondary - Route 2

Infrastructure Planning (Examination Procedure)
Rules 2010

PNR REFERENCE NUMBER
EN010127

| | | | |
|-----------|--------------|------------------|-----|
| ISSUED BY | Oxford | T: 01865 887 050 | |
| DATE | 28 June 2023 | DRAWN | GSP |
| SCALE/D | 1:4,000 | CHECKED | OR |
| STATUS | Final | APPROVED | RP |

DWG. NO 4990-2001-T-072 REV : P0

No dimensions are to be scaled from this drawing.
All dimensions are to be checked on site.
Area measurements for indicative purposes only.

© GDA Design Consulting Ltd. Quality Assured to BS EN ISO 9001: 2015
Source: Ordnance Survey

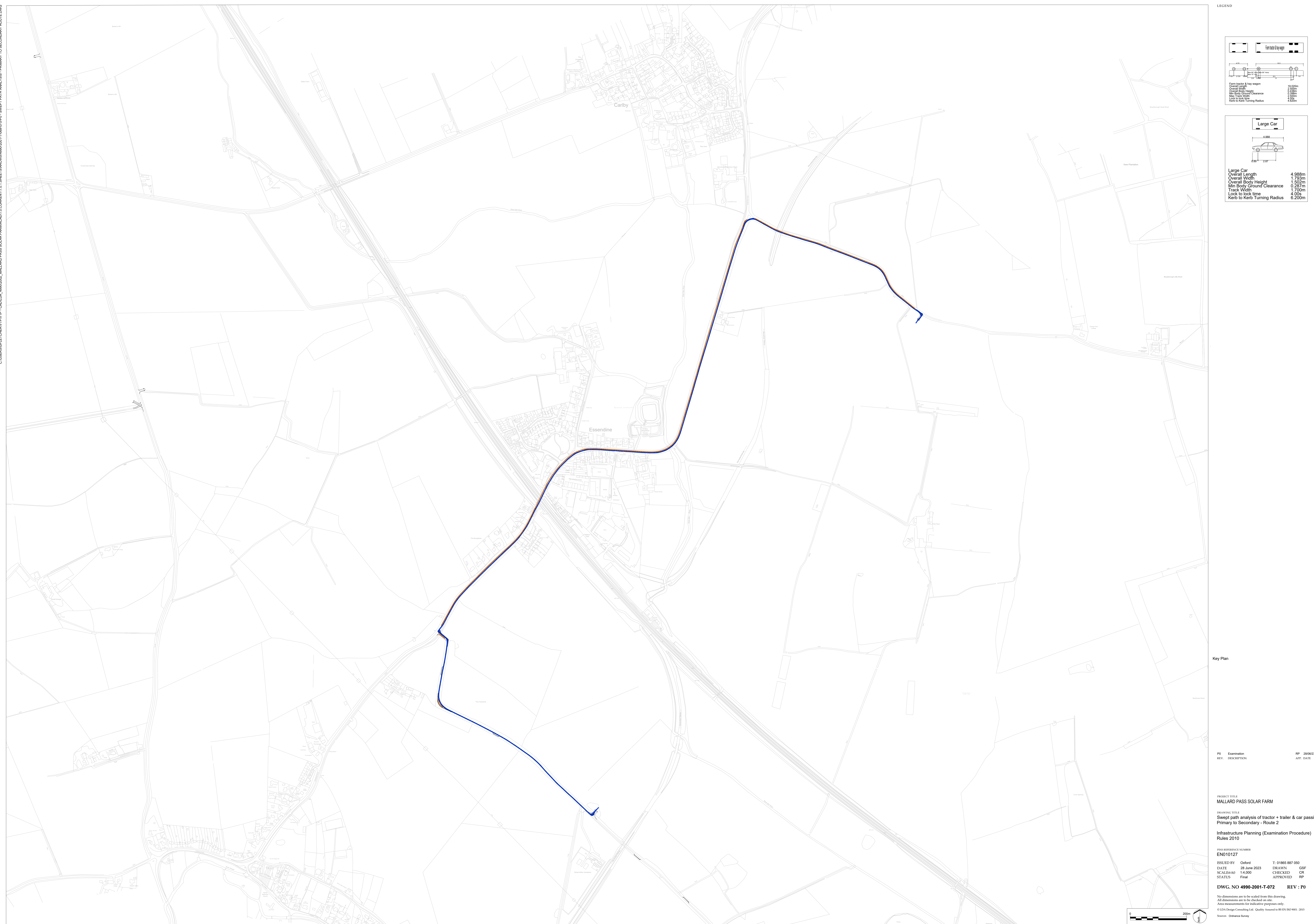

C:\Users\pgle\OneDrive\Work\4990-2001-T-072\Drawings\4990-2001-T-072\Drawings\4990-2001-T-072.dwg

